

Summit 4 x 6 and 5 x 7 Room Owner's Manual with Designer Trend Heater



Precautions Before Use.....	2
Read Before Installation.....	2
Room Assembly.....	3
Electrical Installation	10
Interior Installation	14
Lighting Operation.....	16
Sauna Heater Operation.....	16
Maintenance and Troubleshooting	17

Read all instructions carefully before installation including instructions packaged separately with the sauna heater. Please leave all instructions and warranty with the owner.

WARNING: When using electrical sauna heaters and associated sauna products, basic precautions must be followed, including the following:

1. Grounding is required.
2. No electrical receptacle shall be installed in the sauna room.
3. Be sure rocks are placed in the heater according to the Heater Installation and Operation Instructions.
4. Do not tamper with the door or install a latching or locking system. Malfunction of which may cause entrapment inside the heated room.
5. Do not block ventilation openings. Vents must be kept free of obstruction so proper airflow is maintained in the sauna room. Do not stack anything in front of the vents.

WARNING: Prolonged exposure to elevated temperatures is capable of inducing hyperthermia. Hyperthermia occurs when the internal temperature of the body reaches several degrees above the normal body temperature of 98.6°F. The symptoms of hyperthermia include an increase in the normal temperature of the body, dizziness, lethargy, drowsiness, and fainting. The effects of the hyperthermia include failure to perceive heat, failure to recognize the need to exit the room, unawareness of impending hazard, fetal damage in pregnant women, physical inability to exit the room and unconsciousness.

WARNING: The use of alcohol, drugs, or medication is capable of greatly increasing the risk of fatal hyperthermia.

CAUTION FIRE HAZARD: Do not use the sauna room for drying clothes, bathing suits, etc. Do not hang towels above the heater or place any object, other than the rocks supplied, in the heater. If any darkening of the wall around the heater is noticed, discontinue sauna use immediately.

ROOM ASSEMBLY

- Each panel is heavy. Be careful to avoid injury when installing, especially the roof panels.
- Two adults are required for the installation of sauna room.
- There is a pin or a slot on the front wall and back wall sections, which will be installed correspondently with one pin to one slot in the following way when installing:
 - The panel with pin should be lifted up about 1 inches (2 cm) higher than the panel with the slot.
 - Place the panel with the pin against the panel with the slot, and then slide the panel with the pin down until the two panels are equal in height.
 - If they are not equal in height or there is an obvious gap between the two panels, that means they are not properly attached, and you should try again.

INSTALLATION OF SAUNA ROOM

1. Place the floor panel in the desired location on a level surface

Note: The floor panel must be level before installing wall and ceiling panels. If the surface is not level you may need to shim the floor panel to get it level.

The base is numbered to correspond with the panels for correct locations. The right wall is labeled # 1, the back right panel is labeled #2 and etc...(See picture below)

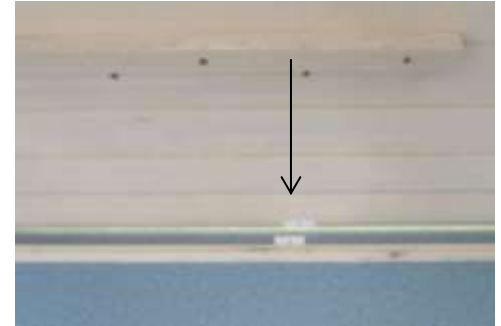

Note: A bead of caulk is required around the outer edge of the floor as each wall panel is placed on the floor. Place the wall panels on the caulk to prevent moisture from penetrating the floor.

2. Place the back right corner wall panel on the outer edge of the floor panel.
3. Place the right wall on the floor and butt it to the back wall.



Note: During wall panel assembly, a bead of caulk is required between each panel to prevent moisture from penetrating the wall panels.

4. Secure the back wall to the side wall with 3" Torq screws provided. Ensure the corner is flush on the outside edge when screws are installed.



5. Secure walls to base of room with 2" Torq screws as each wall panel is added.



6. Place and latch the left side back wall panel to right back wall panel.

Note the locking pins to attach together the back wall.



7. Secure the back wall to the side wall with 3" Torq screws provided. Ensure the corner is flush on the outside edge when screws are installed.



8. Place and screw left right front wall to left side wall.



9. Place and latch the door panel to the left front wall panel.



10. Place and latch the right front wall panel to the door panel and add screws to the right front wall panel to the side wall panel.

Note: During front assembly, a bead of caulk is required between each of the panels and between the walls and the floor to prevent moisture from penetrating the wall panels and flooring.



11. Install the left, center and right support beams from the back of the room through the front wall.

Note the notches in the beams to fit to the walls.

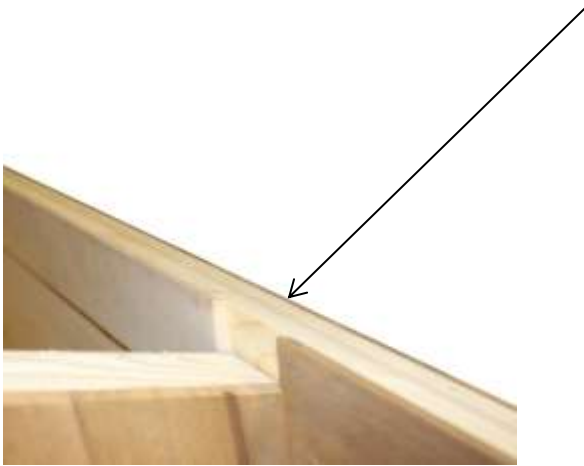

12. Install the 3" Torq screws into side beams.



13. Install the 3" Torq screws at an angle through the front and back walls into the center beam.



14. Place the right ceiling panel on the room. The trim will hold the ceiling on the walls until it can be secured.



15. Repeat 14 for the left roof panel



Note: Ensure the ceiling panels are pushed to the peak before installing screws.

16. See predrilled holes in ceiling. Secure the ceiling to walls with 4" Torq screws.



17. Install the roofing felt on the roof panel using a hammer stapler to prevent moisture from getting on the wood. Put first sheet on at the lower part of each ceiling panel. Overlap the paper over the peak and over each side piece to ensure moisture does not get under the paper. Trim the roofing felt to be flush with the front and back edges of the roof panels.



18. Install roofing, starting from front of the room. The front edge of the first panel should be flush with the front edge of the ceiling panel and 1/2" from the peak of the ceiling. Install two screws of the roofing screws with rubber washers in the sheet metal close to the front of the panel to hold it until all pieces are in place.



Note: Do not place screws in locations which will interfere with the installation of the fascia and the ridge cap at a later step.

19. (4x6 Room) Place the second sheet of roofing so it nearly flush to the back edge of the roof and then overlap the extra material in the middle of the roof to determine final location. Do not extend the metal roofing over the front or back edge of the wood roof.

Note: The ¼” flange overhangs together in the middle of the room.

- (5x7 Room) Place the second sheet in the middle and then the third sheet on the back edge. Overlap the back panel over the middle to make the back panel so it is nearly flush with the back edge of the roof.

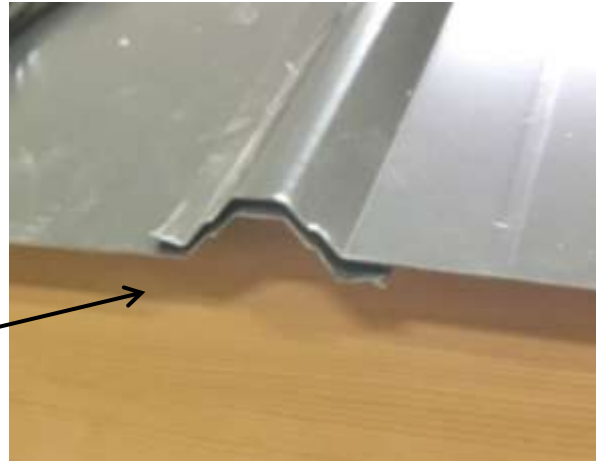

20. Install screws at the top of the corrugation to prevent leaking.



21. Repeat the process on other side of roof and secure all the metal panels

22. Install the first piece (not cut at a 27° angle) of steel fascia on the gable-end of the roof so the top edge of it aligns with the peak of the roof. Depending on how the roofing material was installed, you may need to trim the bottom edge of the fascia close to the eave.

23. Place the second piece of fascia (with the 27° angle bend) on the roof, again aligning it with the roof peak. The angled end fascia should come to the peak and come down the front of the fascia for clean edge.

24. Re-position this piece of fascia and fasten it the same.

25. Install back fascia and repeat the process as front fascia.

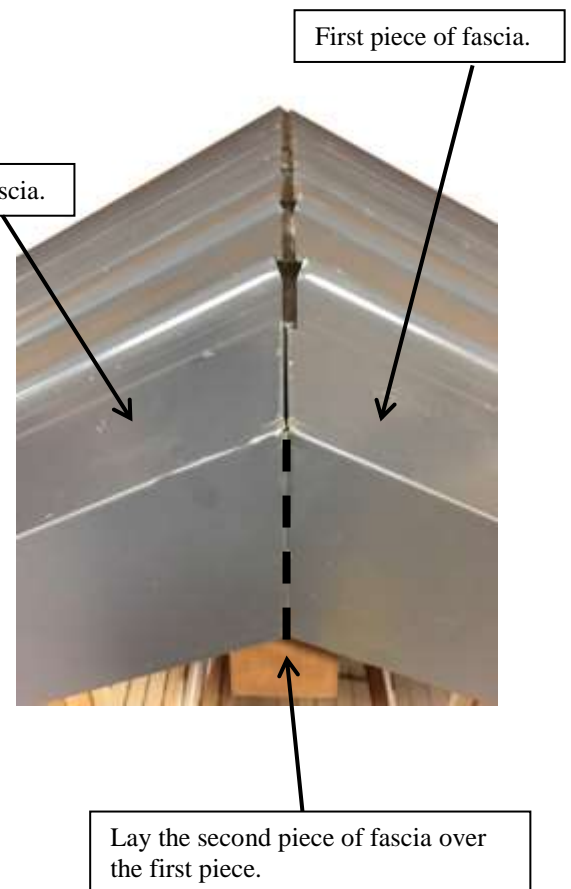

26. Install ridge cap and secure with hardware. Insert foam under the ridge cap to prevent insects from getting under the roofing. See photo below for Ridge Cap foam.



27. Insert foam under the roofing edge to prevent insects from getting under the roofing.



Note: The profile has changed from previous picture to better fit the contour of the roofing.

Note: Roofing screws may need to be loosened to get foam between roofing and ceiling.

ELECTRICAL / HEATER ASSEMBLY

28. Main power for sauna should enter in the room through the back wall. Drill hole where needed to route wire into the room.

Note:

DO NOT Drill in Right Side Wall due to existing wiring.

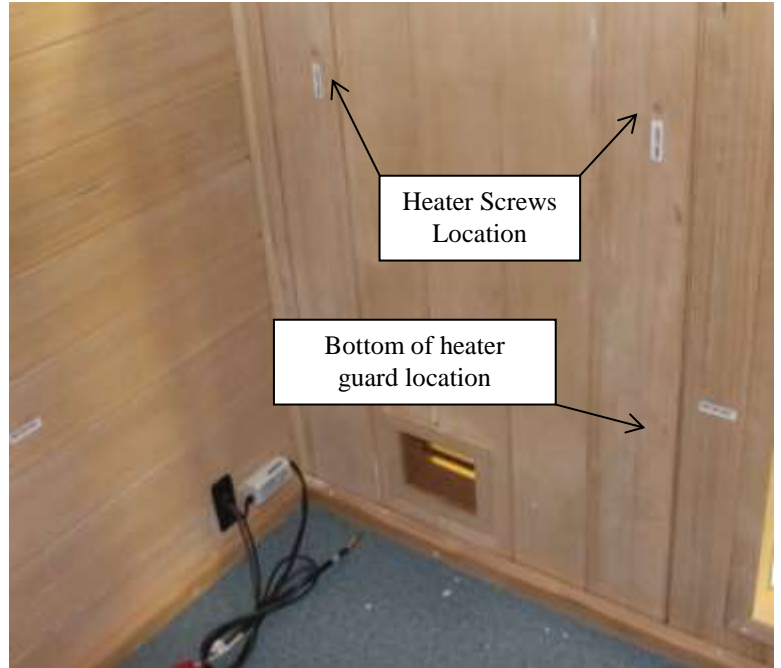

29. Lay heater on its back to connect wires.



30. Remove lower black 3 sided cover and the bottom cover.



31. Route control wire and sensor wire together through the small rubber grommet into the heater.

Control Cable Port

32. Connect to the printed circuit board in appropriate locations.

Sensor Cable Port

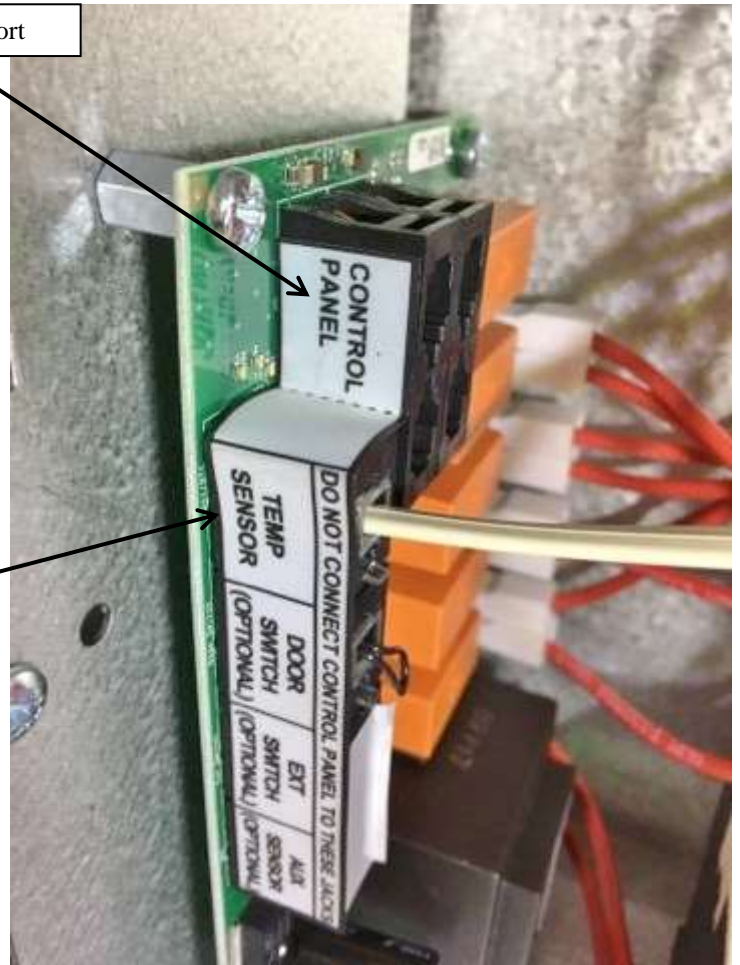

33. Route lighting wire from the wall to the sauna heater and connect to terminal block.

Note: *The Red or Black wire is the Hot wire. The Yellow or White wire is the Neutral wire.*



34. **Note: Refer to Sauna Installation and Operation Manual for complete heater and control wiring information.**

35. Connect wires from building electrical supply to the lower terminal block labeled L1, L2, N, and Gnd through the hole drilled previously in the manual the wall.

36. Connect the wires on the right wall to the back wall for the backrest lighting.



37. Connect the control wire from the right wall to the control.



38. Temporarily connect the backrest to the back wall.

39. Ensure all electrical connections are installed and everything is safe.

40. Apply power to the heater and the control will flash for about 25 seconds as it is booting up.

41. Press the room light button to ensure backrest lights turn on.

42. Press the On button and allow heater to run for 15 seconds and turn off.

43. Put your hands close to the elements (DO NOT TOUCH) to feel if all three elements are heating.

44. Confirm everything is working. After confirmation, do the final installation of the control and heater.

45. Clean the wood around the control wire hole on the right wall and ensure it is dust free before applying the control to the wall.

46. Put the extra control wire in the wall.

47. Place control to the wall to with tape on the back to mark the location to ensure the control is level.



Note: The tape is very difficult to remove after once installed.

48. Remove the tape and mount the control to the wall.



49. Mount the sauna heater according to the Installation and Operation Manual provided with the heater. The wall is labeled and predrilled for the top lag screws from the sauna heater hardware.

50. Install the wood heater guard around the sauna heater using the 1 1/8" screws provided. The heater guard location is marked on both walls with a label. Place the bottom of the heater guard to cover the label on the walls and secure into location.



Interior Installation for 4 x 6

51. Install lower bench in the room after electrical wiring is completed.
52. Install upper bench in the room.
53. Connect the wires from the back of the backrest to the wires from the back wall.
54. Install the backrest to the back wall with screws.

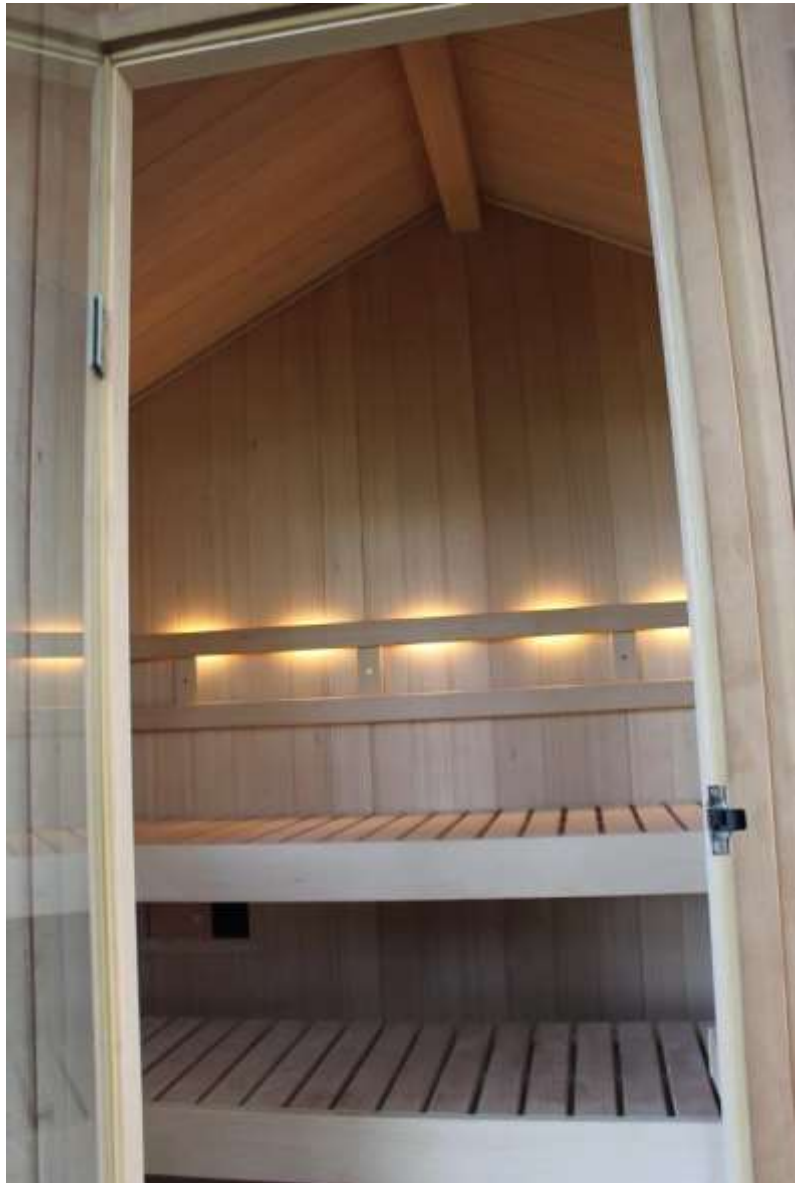

Interior Installation for 5 x 7

55. Install lower bench in the room after electrical wiring is completed.
56. Install support member under the upper bench with screws on the left side of bench.
57. Install the upper bench in the room.





58. Install the return bench in the room between the front wall and the upper bench.

59. Install two screws under the return bench to the main bench.

60. Connect the wires from the back of the backrest to the wires from the back wall and install the backrest to the back wall with screws.

61. Connect the wires from the backwall back rest to the side wall backrest. Then secure the side wall backrest to the side wall.



Two screws under the return bench



TREND CONTROL OPERATION

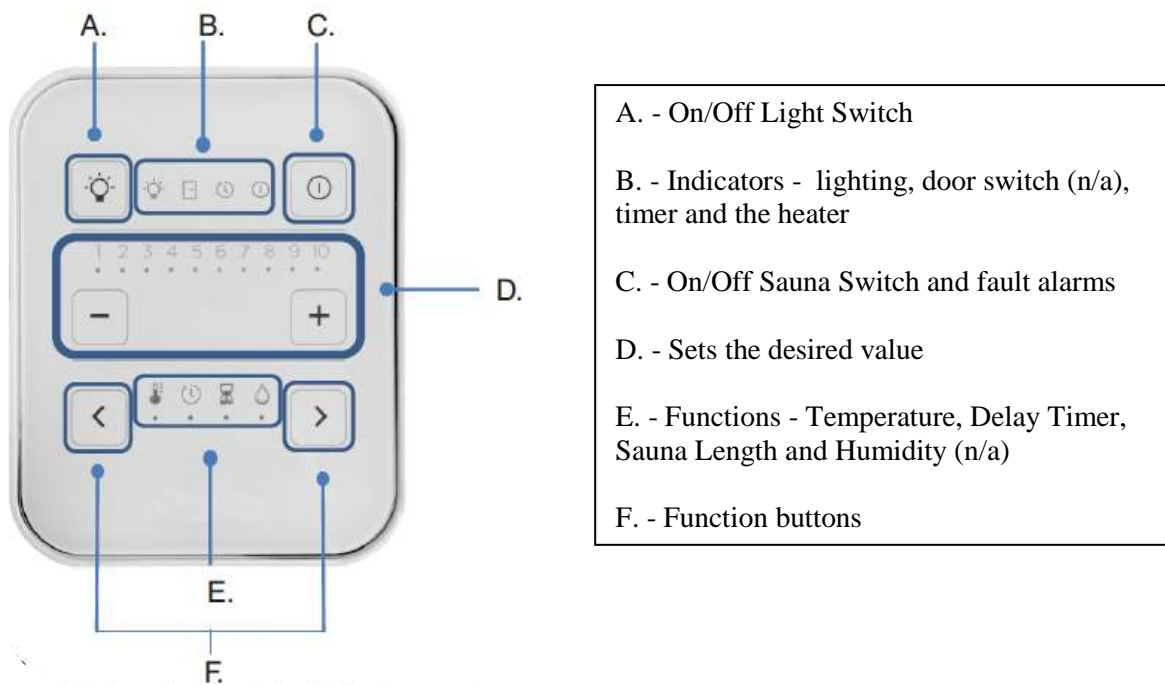

OPERATING INSTRUCTIONS FOR SAUNA HEATER

LIGHT: Press the "light bulb" icon once to turn on the light and press again to turn off.

SAUNA LENGTH: (Select the sauna length function by pressing the buttons < > (F). Set the desired usage time (0–60 minutes) using the – and + buttons. (Setting 10 equals 60 minutes)

TEMPERATURE: Press function button (F). Then you can choose the desired temperature 1–10 using buttons < and >. (Setting 10 equals highest set point.)

START HEAT IMMEDIATELY:

Start the heater on by pressing the On/Off button. The latest temperature and usage time settings will remain preset. The On/Off indicator will glow green while heating. To add more time after system is running, press the On/Off button twice to restart program.

When system is heating , the set temperature indicator LED will remain solid and the current temperature indicator LED will flash. When the current temperature reaches the set value the indicator light will stop flashing.

You may switch the system off before the usage time ends by pressing the On/Off button. The On/Off indicator LED will go out. NOTE: The room light indicator will remain on and it will turn off automatically after 10 minutes.

TIME DELAY START TIME: The control may be set to delay start mode to activate the heater after a preset amount of time. Select the clock symbol using the function button (F). Use the < and > buttons to select the amount of hours (1–10 hours) after which the device will switch on. Activate a later start by pressing the Start button (C).

The timer symbol light will come on (in field B) and the selected time-lapse indicator light will start flashing. The flashing indicator measures and indicates the time leading up to the device being switched on. When the heater starts, the control panel will automatically show the set temperature.

USER MAINTENANCE INSTRUCTIONS

Room Instructions for Cleaning:

Perspiration and dirt may absorb into the wood, so periodic cleaning is needed. Scrubbing the benches and floorboards with a stiff brush and mild detergent is normally sufficient. Light sanding is another option.

Exterior Maintenance:

The exterior should be painted/stained as any outside building.

TROUBLESHOOTING

Control will Run but No Heat - Press the (reset) high limit switch on the back right side of heater.

Slow Heat Time or High Limit Tripping - Check rock placement, they will break down over time and reduce the air flow in the heater. Refer to Sauna Heater Installation and Operation Manual for proper rock installation. Discard all rocks under the size of 2" pieces. Call the number below to order more rocks if needed.

In the event of a fault occurring in the heater system (control panel, temperature sensor, etc.), the LED On/Off indicator will flash red on the control panel.

The fault error code will be displayed with a constant LED light or a flashing LED light under numbers 1-10. See the list below for fault codes.

Constant LED Fault Code (ones marked with "n/a" are not in use):

- | | |
|----|---|
| 1 | Temperature sensor not connected or shorted |
| 2 | n/a |
| 3 | Heater circuit board overheated |
| 4 | n/a |
| 5 | n/a |
| 6 | Communication lost between control and circuit board in heater. |
| 7 | n/a |
| 8 | n/a |
| 9 | n/a |
| 10 | n/a |

Flashing LED Fault Code

- | | |
|----|---|
| 1 | n/a |
| 2 | n/a |
| 3 | n/a |
| 4 | n/a |
| 5 | n/a |
| 6 | n/a |
| 7 | n/a |
| 8 | n/a |
| 9 | Door Switch is open for more than 60 seconds while heating or jumper on circuit board in heater is removed. |
| 10 | Door Switch is open for more than 60 seconds in "Delay" Mode or jumper on circuit board in heater is removed. |

For troubleshooting or service questions call 1-888-780-4427 and ask to speak with service. Prior to calling, please have the Model and Type number available. You may also email us at

techsupport@tyloheloinc.com

