



Premium Control
1601-33 or
1601-33-1

Trend Control
1601-31 or
1601-31-1

Himalaya "Premium" Series Sauna Heaters Models 7.0, 9.0

(Type #'s 1118-702-1707, 1118-902-1707)

with Premium Control (Type # 1601-33 and 1601-33-1)

And/Or Trend Control (Type # 1601-31 and 1601-31-1).

Read all instructions carefully before installation. Please leave all instructions and warranty with the owner.

WARNING

Prolonged exposure to elevated temperatures is capable of inducing hyperthermia. Hyperthermia occurs when the internal temperature of the body reaches several degrees above the normal body temperature of 98.6°F. The symptoms of hyperthermia include an increase in the normal temperature of the body, dizziness, lethargy, drowsiness, and fainting. The effects of the hyperthermia include failure to perceive heat, failure to recognize the need to exit the room, unawareness of impending hazard, fetal damage in pregnant women, physical inability to exit the room and unconsciousness.

WARNING

The use of alcohol, drugs, or medication is capable of greatly increasing the risk of fatal hyperthermia.

SECTION 1: GENERAL INFORMATION

These heaters are ETL approved by Intertek for permanent installations and electrical connections. Built with splash proof construction, the conducting parts are protected against water. All wiring must be performed in accordance with national and local codes. See Diagram 2 for wire and room size requirements. These heaters are floor mounted.

WARNING

Do not take a sauna if using alcohol, drugs or medications.

Pregnant women or persons with poor health should consult their physician before using any sauna.

Caution fire hazard: Do not use the sauna room for drying clothes, bathing suits, etc. Do not hang towels above heater or place any object other than the rocks supplied on the heater. If any darkening of the wall around the heater is noticed discontinue sauna use immediately.

Inspect sauna regularly for required maintenance to heater, control and benches. Replace wood surfaces which show any signs of deterioration.

The heater gets extremely hot during operation and should not be touched or burns may result.

Minors should be adequately supervised whenever near a hot or warming sauna.

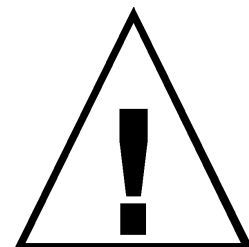
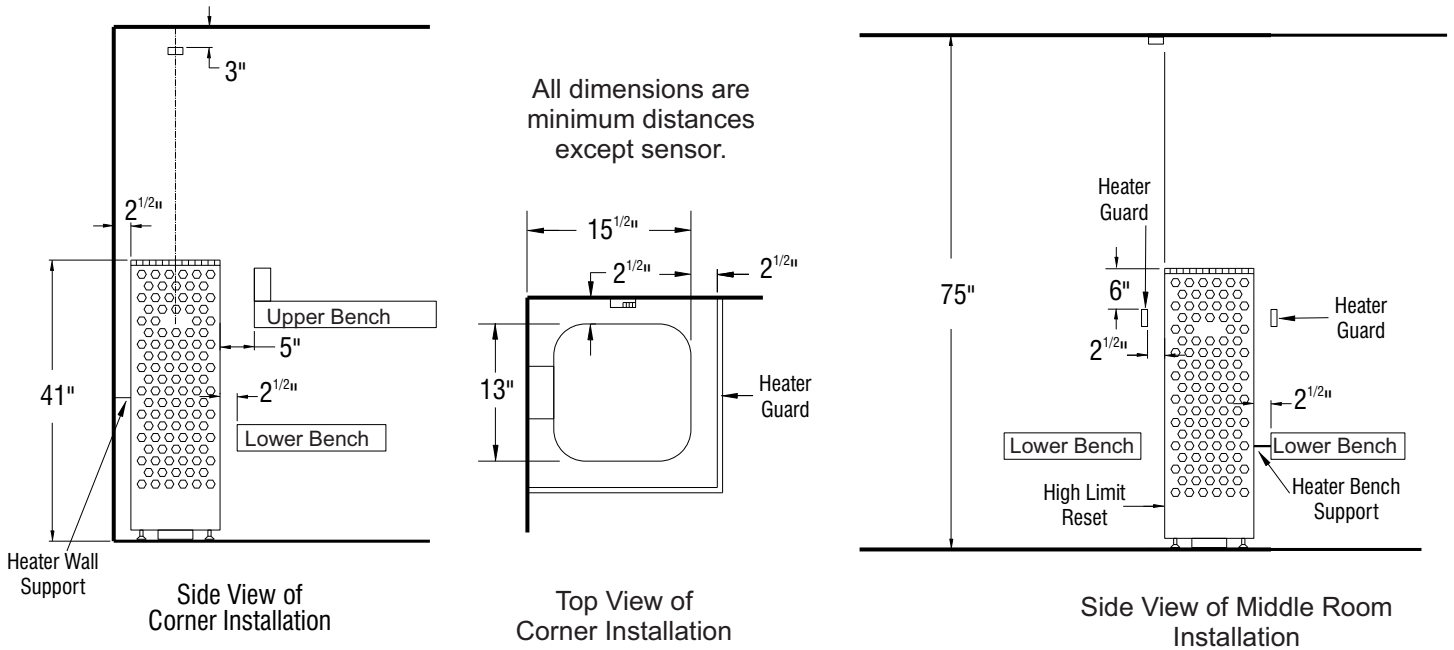

DIAGRAM 1

MOUNTING BRACKET LOCATION AND MINIMUM DISTANCE TO COMBUSTIBLE MATERIAL



Recheck your distances from the heater to combustible materials to be sure you have the proper minimum distances.



OBSERVING MINIMUM DISTANCES IS REQUIRED TO REDUCE THE RISK OF FIRE

DIAGRAM 2

HEATER MODEL / Product Number	KW	MINIMUM ROOM			MAXIMUM ROOM		PHASE	VAC	AMPS	WIRE SIZE
		Floor Area	Wall Height	Volume Cu.Ft.	Wall Height	Volume Cu.Ft.				Power Supply to Heater
Himalaya Trend 7.0 1118-702-1707	6.8	21 sq. ft.	75"	175	96"	350	1	208	32.7	2 #8AWG+N+GR
							1	240	28.3	2 #8AWG+N+GR
							3	208	18.9	3 #10AWG+N+GR
							3	240	16.4	3 #10AWG+N+GR
Himalaya Trend 9.0 1118-902-1707	9.0	38 sq. ft.	75"	310	96"	500	1	208	43.3	2 #6AWG+N+GR
							1	240	37.5	2 #6AWG+N+GR
							3	208	25.0	3 #8AWG+N+GR
							3	240	21.7	3 #10AWG+N+GR

NOTE 1: Neutral is required for heater and control to operate. Light output from heater is 120 volts at 2 amps maximum.

SECTION 2: MOUNTING OF SAUNA HEATER

-NOTE: Complete electrical connections and test the heater prior to this step.

Attach wall bracket to any of the mounting holes located on either side of the spine on the rear of the heater shroud (reference diagram 4). Slide heater into position, according to dimensions shown in Diagram 1 and mark locations for the two mounting screws. Slide heater forward and screw two 1/4" x 1" lag bolts into sauna wall at locations marked earlier, leaving approximately 1/8" of bolt shoulder exposed so bracket can easily slide over bolt heads. Re-locate heater into position with key-holes of bracket locking onto lag bolts. Adjust the leveling feet to ensure that the heater is vertical. Use a level on two sides of heater to verify plumb.

If mounting heater in center of room, use same procedure described above but locate mounting bracket so that it can attach to the bench framing that surrounds the heater.

SECTION 3: PLACING OF ROCKS (SEE DIAGRAMS #10 and 11)

The rocks supplied have been chosen to provide the best heater performance. Use of any other type of rock may void the heaters warranty. Never operate the heater without rocks in place! Rinse the rocks with water before placing in the heater.

Install the BWT (Bio Water Technique) tank between the second and third heating elements resting on the top of the elements. (See diagram 11) The BWT tank has slots in the outer flange that will align with the element loops. Install the BWT cover and the round herb cup.

Start inserting rocks into the heater in even layers so that the 3 heating elements remain as vertical and evenly spaced as possible. Continue to randomly drop rocks into the heater until you are even with the top of the heating coils. Add one more loose layer to cover up the elements and top of the BWT. (Do Not Cover Up the round herb cup on top of the BWT!) The rocks must fully cover the heating elements. Attach the guard with the screws provided. See Diagram #10 & 11 for rock placement.

Packing the rocks too tightly may cause the heater high limit switch to trip.

SECTION 4: ELECTRICAL HOOK-UP

Electrical installation must be made by a licensed electrician in accordance with the National Electrical Code and local regulations.

- NOTE: A GFCI (Ground Fault Circuit Interrupt) device is not required by ETL. A GFCI may be installed if required by local codes but will nuisance trip during use of the product. - CAUTION: Loose wire connections can cause heat damage to wires, terminal blocks and other components and may void the warranty.

Remove the screws from the left and right sides of the electrical box. Remove the painted trim piece from the front of the box. Route the feed wires through the holes provided in the bottom of the heater and connect the wires to the terminal block. To determine the correct wire size, refer to Diagram 2. Use copper supply wire only, suitable for minimum 90 degrees C. The heater must be grounded! See Diagram 6 for proper connections.

SECTION 5: TEMPERATURE SENSOR

Feed the "low voltage" sensor wire from the sensor to the sauna heater location. Sensor wire must be routed completely separate (as per low voltage electrical wiring codes) from any wiring carrying over 50 volts. It may be necessary to drill holes to string the wire through the studs or ceiling joists. Route the wire to bottom of the heater and connect to the sensor connection. Mount sensor to finished wall 3" from the ceiling directly above the heater using two (2) screws (provided) as shown in diagrams 1, 3 & 5.

If mounting heater in the middle of your sauna room, locate the temperature sensor on the ceiling above the heater at a point directly above one outer edge of the sauna heater shroud. See Diagram 1.

WARNING

Fire sprinkler systems used inside any sauna room should be properly rated for sauna room temperatures.

Do not place hands and or arms over the BWT when hot. Steam from BWT may cause severe burns.

Do not pour chlorinated pool or spa water on heater or in the BWT.

Excessive water use on heater may cause damage and void warranty.

Electric Shock Hazard - High voltage exists within this equipment. There are no user serviceable parts in this equipment. All installation and service to this equipment should be performed by qualified licensed personnel in accordance with local and national codes.

Do not construct sauna room so as to restrict air flow through the bottom of the heater.

Packing the rocks too tightly may cause the heater high limit switch to trip.

DIAGRAM 3

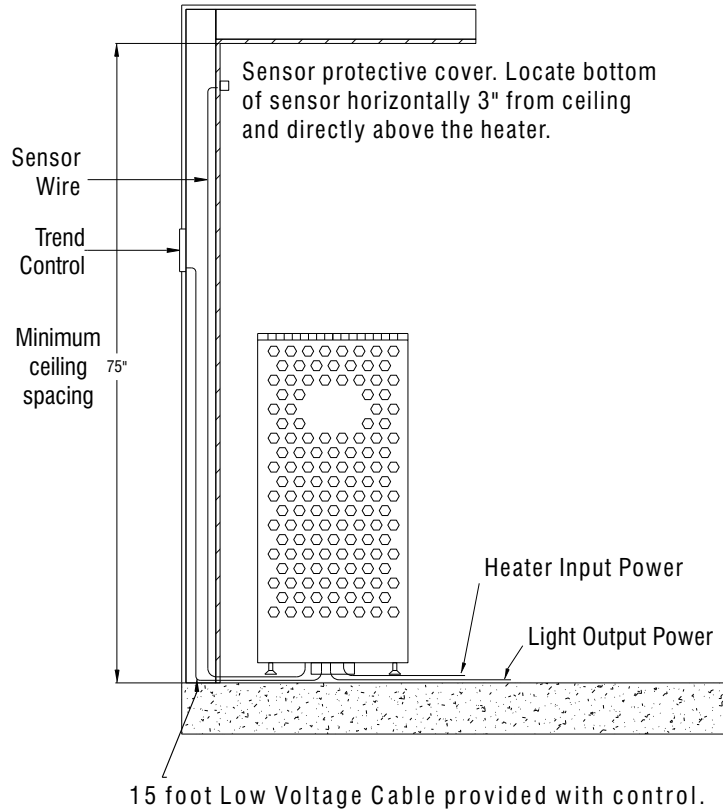
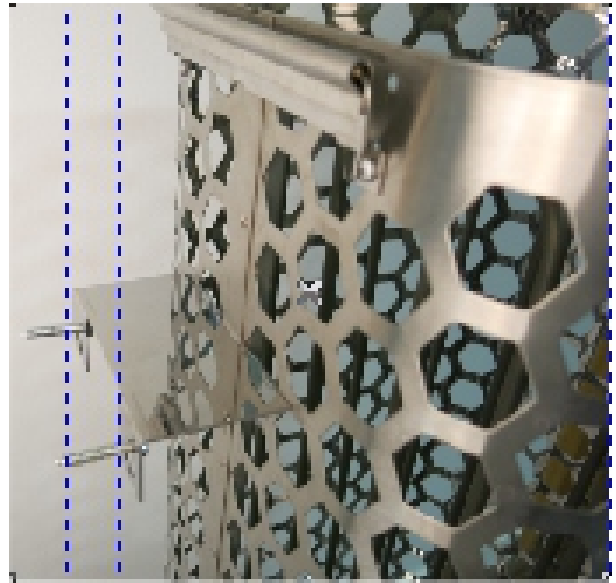

DIAGRAM 4



Bracket fits in any hexagon opening and then screws to the wall or bench.

DIAGRAM 5

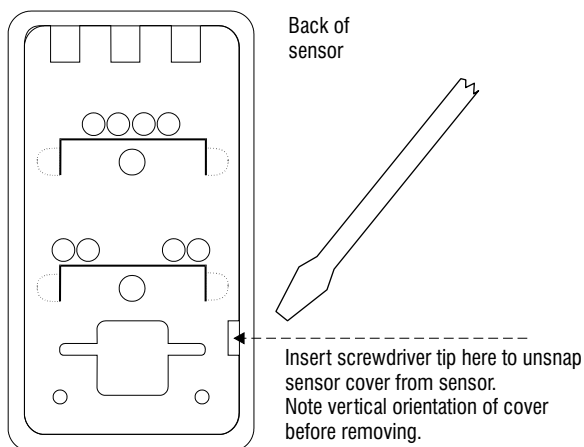

DIAGRAM 5, continued

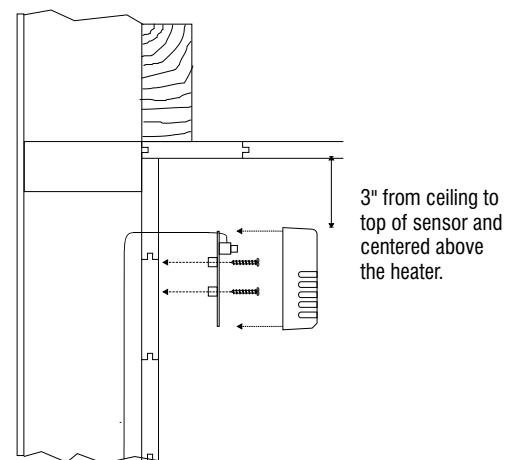

DIAGRAM 6

Single Phase Wiring Diagram Color Code

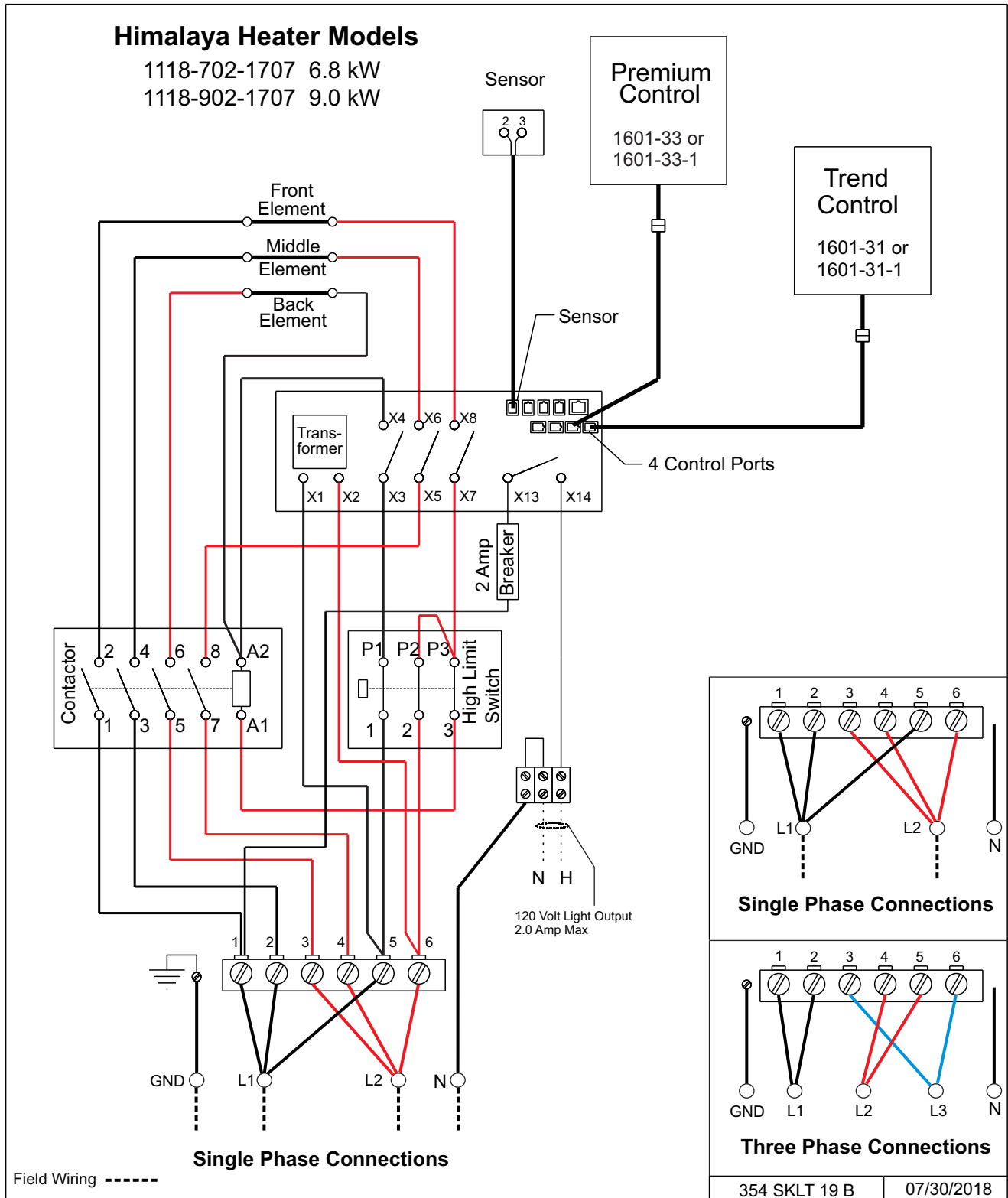
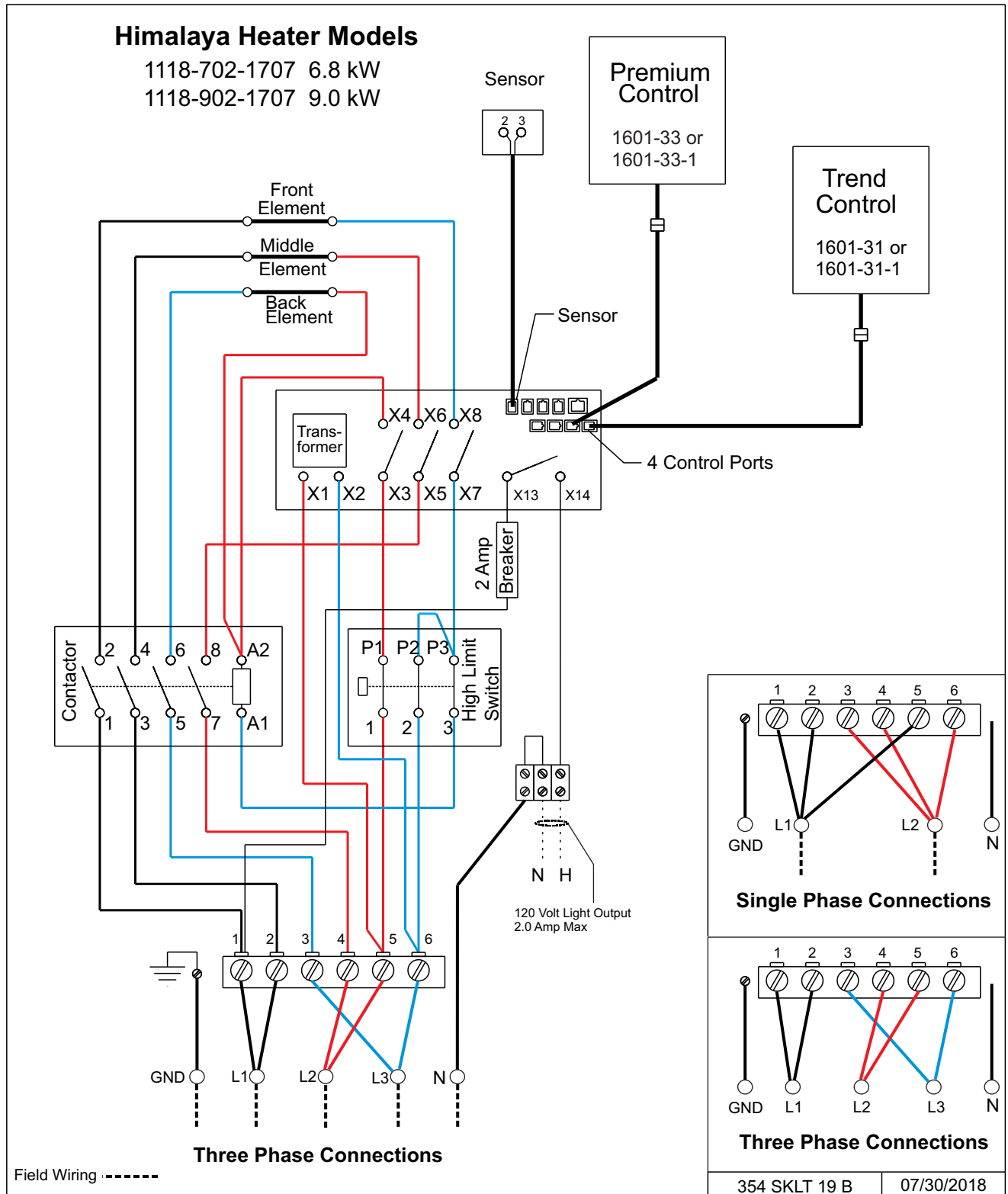

DIAGRAM 6

Three Phase Wiring Diagram Color Code



SECTION 6: HEATER GUARD RAIL

Install a wooden heater guard to prevent the sauna bather from accidentally touching the sauna heater. Install the heater guard rail with the dimensions shown in Diagram 1.

SECTION 7: CONTROL INSTALLATION & OPERATION

CONTROL OPTIONS: This heater has two different control options. A Premium Control (1601-33 or 1601-33-1) or Trend Control (1601-31 or 1601-31-1) can be connected to the heater. This heater can support both at the same time as another option.

INSTALLATION ROUGH IN: Place the control inside or outside the sauna room. If the control is installed inside a sauna room, the top of the unit cannot be higher than 48 inches above floor. Maximum control cable length is 100 feet.

String the provided low voltage control cable through 1" holes in the wall studs or ceiling joists from the control location to the heater. Do not use staples to secure the low voltage cable, it may damage the cable!

Plug the control cable into the control and TEST the control BEFORE mounting!!

Premium Control can be SURFACE MOUNTED or RECESSED MOUNTED.

SURFACE MOUNTING CONTROL: After testing is complete, CLEAN the mounting surface to ensure it is free from dust. Remove the adhesive tape from the back of the control, push any excess cable into wall cavity and press the control to the mounting surface. (Do not use the Mounting Box or Trim Ring for this installation.)

RECESS MOUNTING: See page 22 for information.

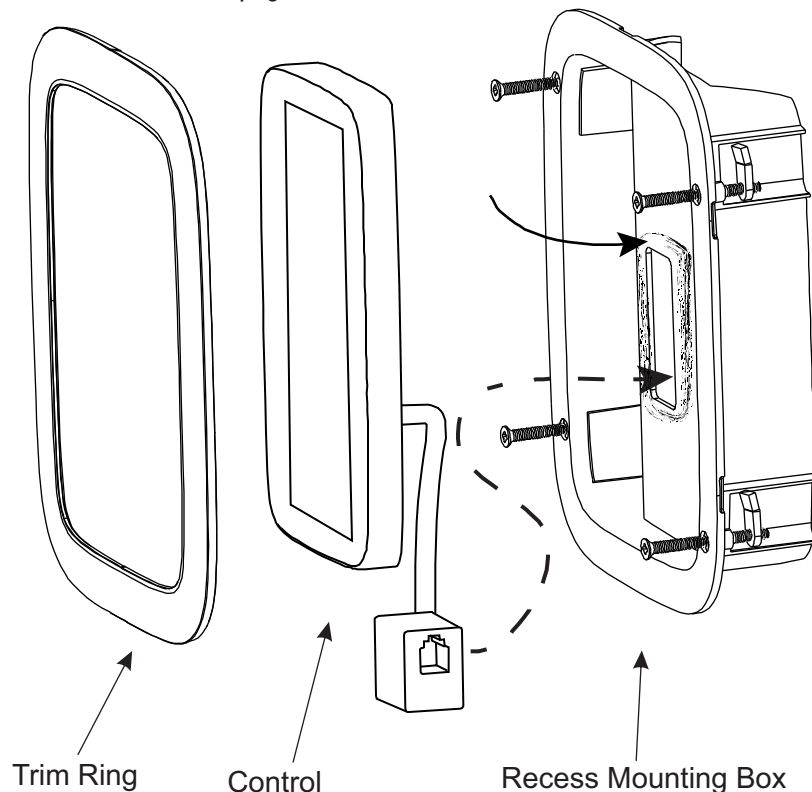

WARNING

Do not locate benches over heater. Refer to Diagram 1 for minimum clearance of ceiling above heater is required.

Minimum clearance from heater to wooden surfaces (benches, side walls, heater fence etc.) is required. Refer to Diagram 1 for specific information.

Mounting brackets supplied. Provides proper clearance from wall behind heater.

Use only copper wire of the size and type indicated in the Heater Specification Chart and the temperature rating indicated on the heater junction box.

All heaters and controls must be grounded per NEC to prevent electrical shock in case of unit failure.

Electrical outlets or receptacle must not be installed in a sauna room.

A guardrail or fence is required around the heater to prevent burns from accidental contact.

SECTION 7: PREMIUM CONTROL (1601-33 or 1601-33-1) OPERATION

Home Screen

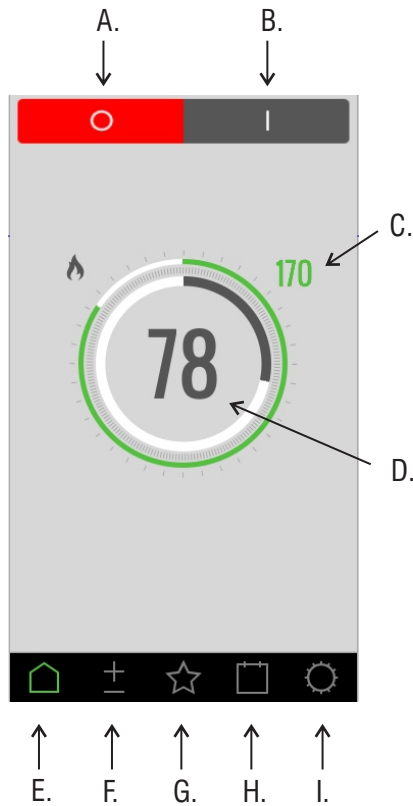

- A. - Off Button
- B. - On Button
- C. - Set Point Room Temperature
- D. - Current Room Temperature
- E. - Home Button
- F. - Temperature Button
- G. - Favorites Button
- H. - Calendar Button
- I. - Settings Button

To Start Immediately

1. Press the  icon in the upper right corner
2. Icon will change color 
3. System has started

Note: The sauna room set point temperature is D.
The sauna room current temperature is E.



The **Home** button: touch this to return to the main screen. Here you will see the current temperature in the steam room, the bath temperature setting, the remaining bath time (if any) and the time of day. Touch the screen to show the bath and Warm Start on/off buttons, too.



The **Settings** button: touch this to display the Settings screen. Here you can adjust the temperature and duration for the current bath. You can also manually turn on the installed options when the bath is on (and turn on some options, such as Lights, when the bath is off). You can also save your settings as a favorite so you can always have them available for your steam bath without having to change settings after someone else has a steam bath.



The **Favorites** button: Here you can select a bath with your favorite settings, once you've saved it.



The **Calendar** button: Here you schedule a steam bath to start and run at a later time. You can select by the day of the week or using a calendar month and select for one time bath or recurring.



The **Tool** button: here you make the many selections for what functions and options are available to be used, set a PIN to limit who can change settings, and much more.

The **Change Menu** arrows are used to move between related menu screens. Press < to return to the previous screen or > to continue to the next one.

SECTION 7: PREMIUM CONTROL (1601-33 or 1601-33-1) OPERATION, Continued

Temperature Screen Options

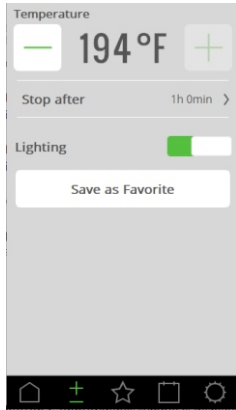

Temperature and Room Light

Change temperature by pressing + or - to desired temperature.
 Press the Lighting icon to turn On or Off the room light.
 Press Screen
 Press button in upper right corner to start sauna.

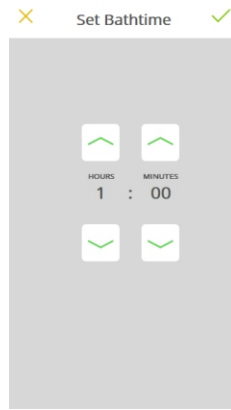

Sauna Duration

Change sauna length by pressing the **Stop After** button
 Change to desired length (normal setting is 1 hour)
 Press the to accept the change



Creating Favorites

Ensure temperature and sauna length are correct.
 Press **Save as Favorite**
 Type in Name and press
 Press the to accept information.

Favorites Screen Options

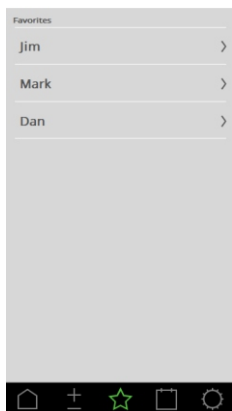

Favorites

Select the Favorite to edit or start program

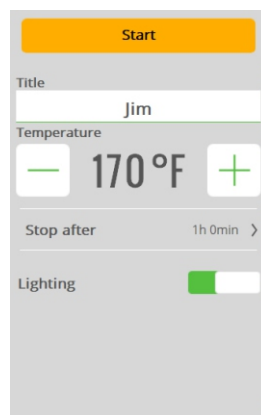

Favorite's Settings

Click on Title to change name
 Change temperature by pressing + or - to desired temperature.
 Change to desired length (normal setting is 1 hour)
 Press to activate program.

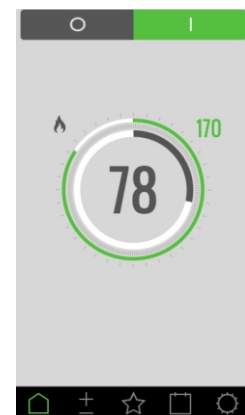

Home Screen

Home Screen will appear and the sauna heater will be started. The temperature setting is the favorite just chosen.

SECTION 7: PREMIUM CONTROL (1601-33 or 1601-33-1) OPERATION, Continued

Calendar Screen Options

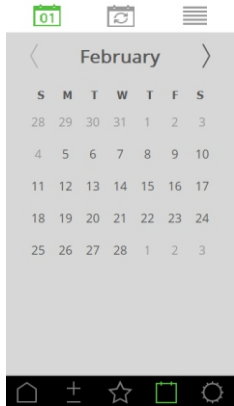

Adding One Time Event

Click the date for the event.

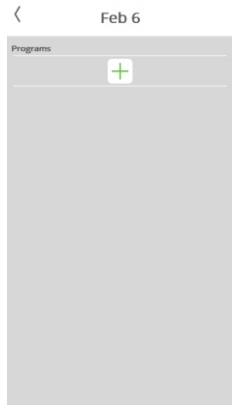

Adding One Time Event

Click the + to add event.

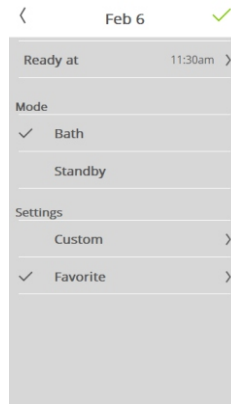

Adding One Time Event

Select the sauna duration and temperatures.

Press the ✓ to accept information.

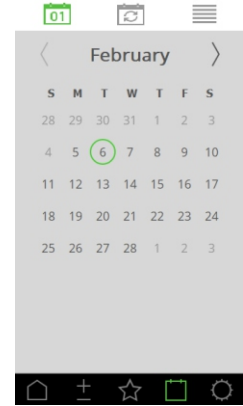

Calendar Showing Event Scheduled

The  indicated a program is scheduled on the date.

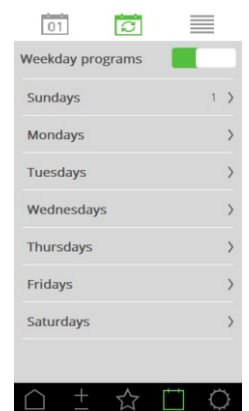
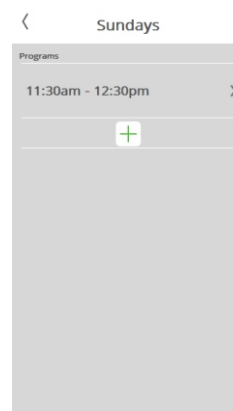
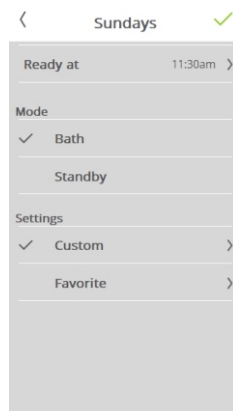
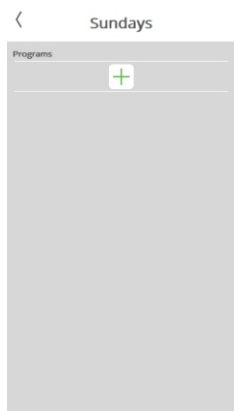
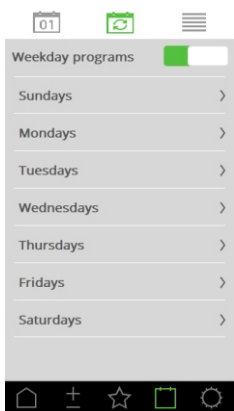

Adding Recurring Event

Select the  button at the top of screen to chose Recurring Event

Click the day of the week for the event.
Select the + to add event.

Select the sauna duration and temperatures.

Press the ✓ to accept information.

Next screen will show 1 event created for the day of the week.

Repeat the process to create multiple events.

SECTION 7: PREMIUM CONTROL (1601-33 or 1601-33-1) OPERATION, Continued

Calendar Screen Options

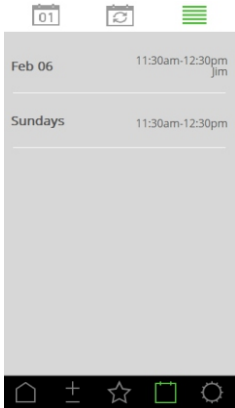

Viewing Scheduled Events

Click the  in the upper right corner to see events.

Setting Screen Options

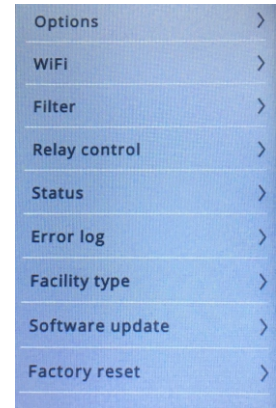
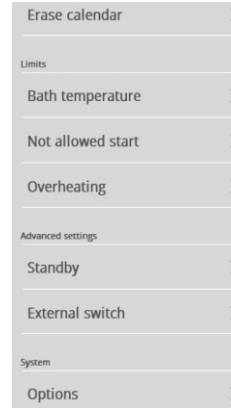
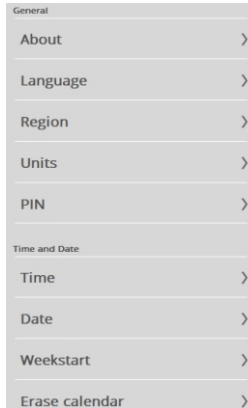

Setting Options

Select the  icon in the lower right corner of the control to access settings.

WiFi Setup Screen

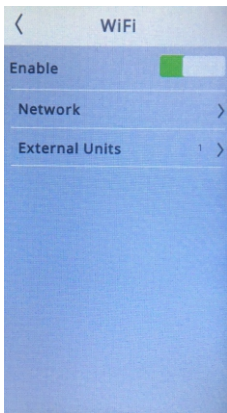

Connect Control to WiFi Network

Select the WiFi option from Setting Screen

Select Network Option

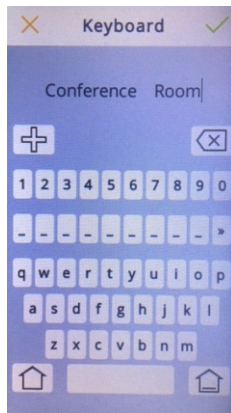

Select Name

Select Name and name the Control

Enter Name and select  to accept.

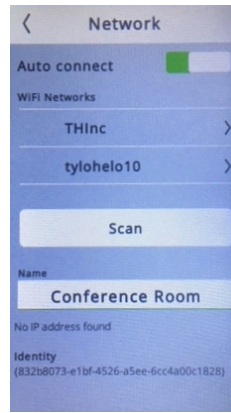

Choose WiFi Network

Select Scan to see all Wifi Networks

Select network to connect

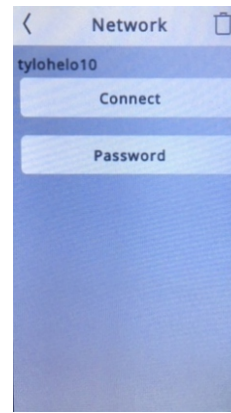

Connect Control to WiFi Network

Select Password

Enter password and select  to accept

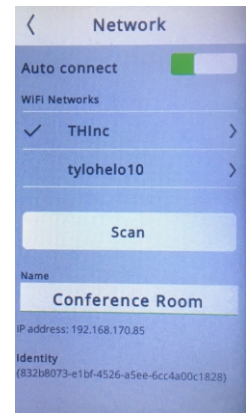

WiFi Network

Check mark indicates control is connected to network

Networking: This control can connect to a Local WiFi Network to be operated by a Phone Application or PC Application. Download the application from the Google Playstore or Apple Store. Search for sauna brand name and download the free application.

SECTION 7: PREMIUM CONTROL (1601-33 or 1601-33-1) OPERATION, Continued

Phone Application Setup Screen

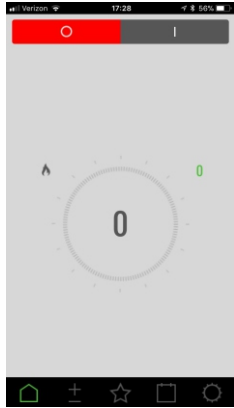

Application Home Screen

Select the Settings  icon.

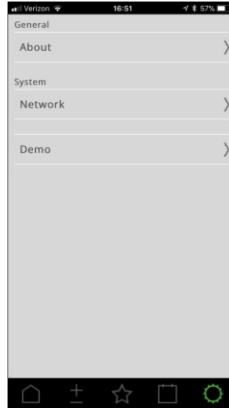

Network

Select network

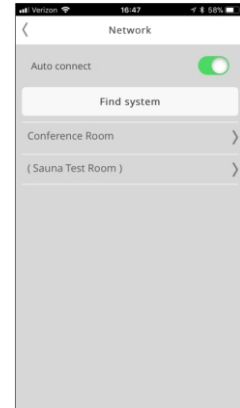

Choose Sauna Control

Phone must be connected to the same network as Sauna Control

Press Find System

Choose Control

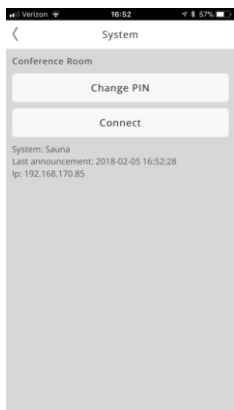

Connect to Control

Select connect

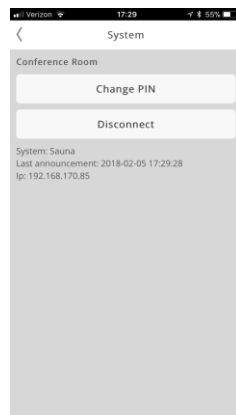

Network Screen to Home Screen

Select the < in upper left corner to go back one screen to Network Screen

Select the < in upper left corner to go back one screen Home Screen.

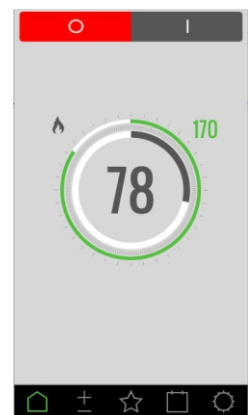
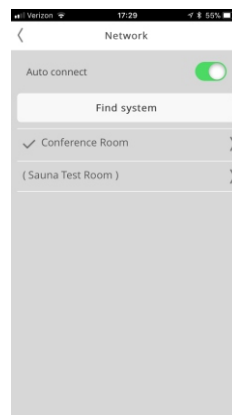

SECTION 7: TREND CONTROL (1601-31 or 1601-31-1) OPERATION, Continued

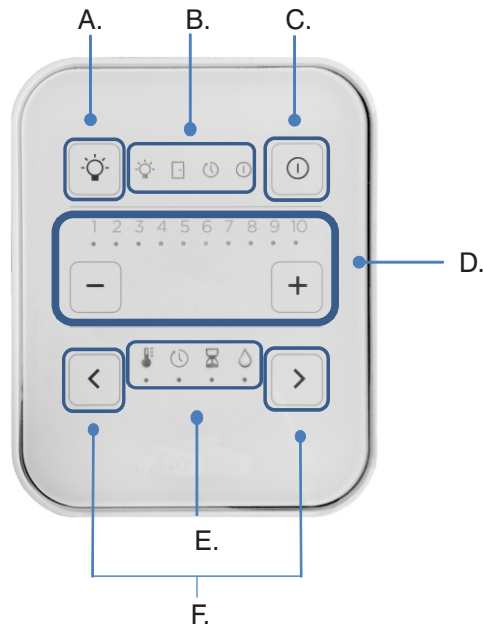

- A. - On/Off Light Switch
- B. - Indicators - lighting, door switch (n/a), timer and the heater
- C. - On/Off Sauna Switch and fault alarms
- D. - Sets the desired value
- E. - Functions - Temperature, Delay Timer, Sauna Length and Humidity (n/a)
- F. - Function Select Buttons

CONTROL OPERATION:

TURN ON LIGHT: Press the "light bulb" icon once to turn on the light and press again to turn off. (Usage of light control is optional)

SAUNA LENGTH: (Control 1601-31) Select the sauna length function by pressing the buttons < > (F). Set the desired usage time (0–60 minutes) using the – and + buttons. (Setting 10 equals 60 minutes)

(Control 1601-31-1) Usage time is 0 - 24 hours operation
(Setting 1 = 2 hours, setting 10 = 24 hours)

	LED									
Version	1	2	3	4	5	6	7	8	9	10
1 hour	6 min	12 min	18 min	24 min	30 min	36 min	42 min	48 min	54 min	60 min
24 hour	2 hr	4 hr	6 hr	8 hr	10 hr	12 hr	14 hr	16 hr	18 hr	24 hr

SECTION 7: TREND CONTROL OPERATION, Continued

SET TEMPERATURE: Press function button (F). Then you can choose the desired temperature 1–10 using buttons – and +. (Setting 10 equals highest set point.)

When the desired temperature has been set and the heater is switched on, the set temperature indicator light will remain on and the current temperature indicator LED will flash. When the current temperature reaches the set value the indicator light will stop flashing.

START HEAT IMMEDIATELY:

Start the heater by pressing the On/Off button. The latest temperature and usage time settings will remain preset. A green indicator light will come on in area (B) to indicate that the device has been switched on.

You may switch the system off before the usage time ends by pressing the same button again. The indicator light will go out.

TIME DELAY START TIME: The control may be set to delay start mode to activate the heater after a preset amount of time. Select the clock symbol using the function button (F). Use the – and + (D) buttons to select the amount of hours (1–10 hours) after which the device will switch on. Activate a later start by pressing the Start button (C).

The timer symbol light will come on (in field B) and the selected time-lapse indicator light will start flashing. The flashing indicator measures and indicates the time leading up to the device being switched on. When the heater starts, the control panel will automatically show the set temperature.

SECTION 8: HIGH LIMIT CONTROL (RESET BUTTON)

The sauna heater has a built-in high limit control, which automatically turns off the heater if the temperature inside in the sauna room rises to an abnormally high level.

To restart the heater, let the heater cool, then push the reset button on the lower back left corner of the heater, see Diagram 1. If the high limit continually shuts off the heater, refer to Section 15 for Troubleshooting.

SECTION 9: HOW TO TAKE A SAUNA

- When taking a sauna, allow time to relax completely.
- Remove clothing and jewelry...if required, wear a towel loosely.
- Some sauna bathers enjoy the soothing effect of steam by splashing water on the heated sauna rocks. Use only one dipper full (approx. ½ cup) at a time and keep clear of the steam as it rises off the rocks.
- This heater has a BWT provided and must be installed in the heater.
- Water in the BWT will add a continuous humidity to the sauna room. Additional water can be poured onto the hot rocks at any time to boost the steam level.
- Fill tank with approximately 2 cups of fresh tap water when heater is turned on (never use water from a pool or spa!)
- Heater can operate with BWT tank empty if user does not want constant steam.
- You may add fragrance oils to the BWT if desired.
- Do not pour chlorinated pool or spa water on the heater or corrosion damage may result.
- After 10 minutes or when perspiration begins, leave sauna and relax in dressing area... follow with a cool shower.
- Cooling time should equal time spent in sauna. Enter sauna room again and stay 5 or 10 minutes.
- Repeat the cycle 2 or 3 times; end with a brisk shower...rinse in cool water.
- Dress when completely dry and perspiration has stopped.
- Do not smoke, exercise or drink alcoholic beverages in the sauna room.



Shower



Sauna (10 - 15 min.)



Shower or swim



Rest (10 - 15 min.)



Relax with juice or water

You liked it?
Do it once again and
you will feel great.

DIAGRAM 7

TYPICAL PRE-CUT WALL CONSTRUCTION

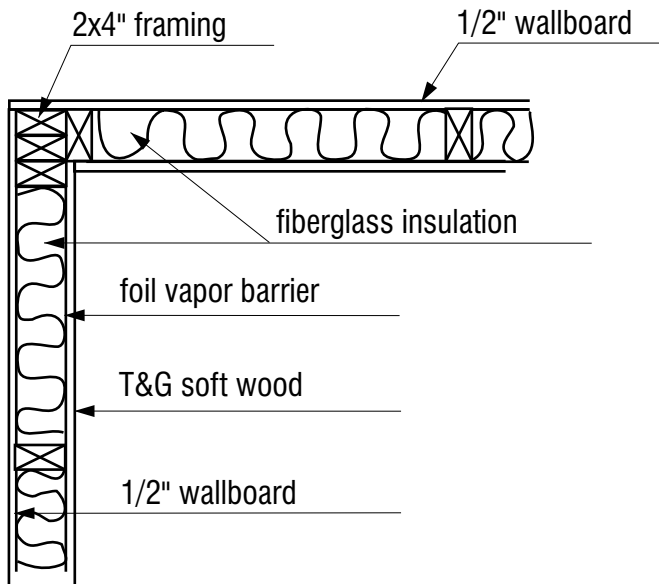

DIAGRAM 8

HEATER SCREEN (GUARD RAIL)

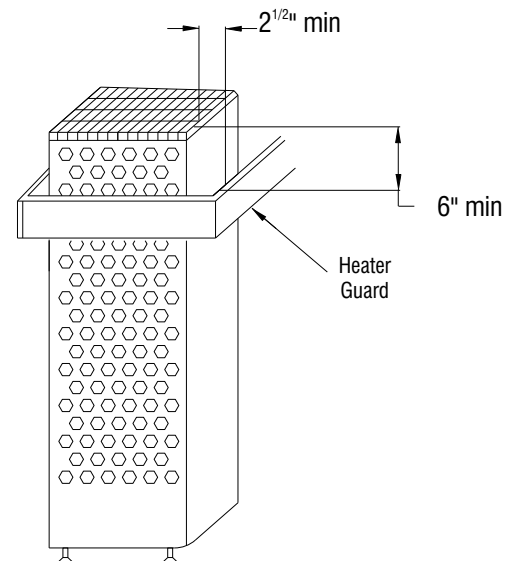

DIAGRAM 9

VENTILATION

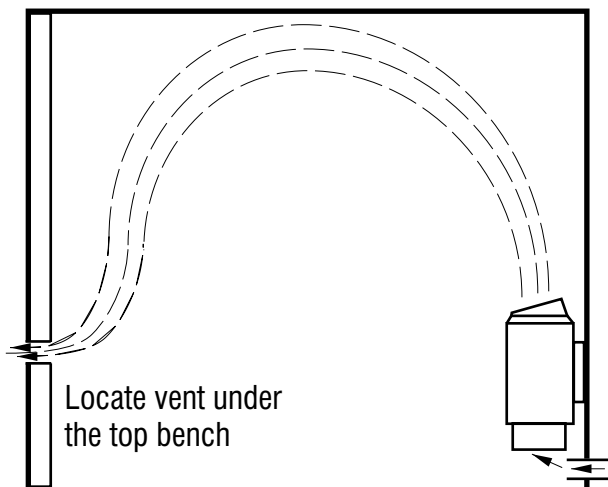
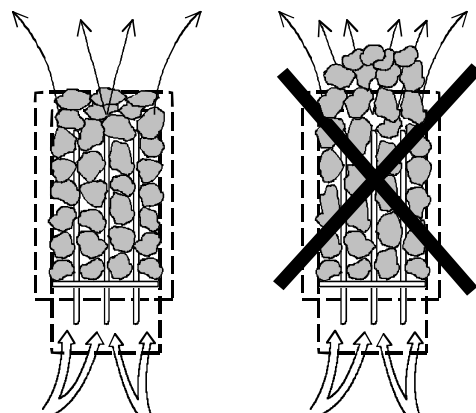

DIAGRAM 10



1. Put smaller rocks in first around the outer perimeter of the heating elements in layers.
2. Fill the middle sections with larger rocks.
3. Ensure the elements are vertical while filling the heater with rocks.
4. Place rocks loosely in the center of heater to allow heat to rise easily up in the middle of heater.
5. Be sure rocks completely cover the elements.
6. Loosely cover the tops of all elements with rocks.
7. Place heater grill on heater.

DIAGRAM 11



BWT tank hangs on the top of the heating elements.



BWT tank, tank lid, and the vent cover installed and the rocks placed around the tank.

SECTION 10: WARNING PLACARDS

Three metal placards are included in the Installation Instruction Envelope packaged with every Sauna Heater. The CAUTION placard must be attached to the interior wall of the sauna room directly above the heater where it is visible to the bather. The French and English WARNING placards must be attached to the door of the sauna room.

SECTION 11: ROOM CONSTRUCTION

For safety and reliability, the following rules must be addressed.

- No permanent locking or latch system is to be used on the sauna door.
- Acceptable door fittings are: magnetic catches, friction catches, spring or gravity loaded closures. The door must always open outwards.
- No shower may be installed in a sauna room.
- No electrical receptacle shall be installed inside the sauna room.
- The enclosed WARNING: Reduce the risk of overheating ... warning plate must be mounted on or alongside the door outside the sauna room at about eye level.
- The enclosed CAUTION: Reduce the risk of fire ... caution plate must be mounted on the interior wall above the heater.
- The heater should not be operated without its container properly filled with rocks and the rock guard in place.
- If an intercom speaker is installed, it should be away from the heater and as close to the floor as possible.
- If a room light is installed, it should be a surface mounted bracket type. Wall mounted lights should be about 70" above the floor. Ceiling mounted lights should be of an approved type with a junction box that is remote to the fixture itself. Use only a fixture that uses A.F. or fixture type internal wiring. A 60 watt bulb should provide sufficient lighting.
- Fire sprinkler systems installed inside any sauna room should be properly rated for sauna room temperatures.
- Always install the heater according to these installation instructions.

WARNING

The "CAUTION" and "WARNING" placards must be mounted in accordance with Section 10.

WARNING

REDUCE THE RISK OF OVERHEATING

- * Exit immediately if uncomfortable, dizzy, or sleepy. Staying too long in a sauna is capable of causing overheating.
- * Supervise children at all times.
- * Check with a doctor before use if pregnant, in poor health, or under medical care.
- * Breathing heated air in conjunction with consumption of alcohol, drugs, or medication is capable of causing unconsciousness.

CAUTION

REDUCE THE RISK OF FIRE

Do Not Place Combustible Material On The Heater At Any Time.

For safety purpose sauna door must open out and not lock.

Never use a wood stain, seal or preservative on the inside of your sauna room.

Light fixtures get very hot during operation. Locate light fixture where it will not be a burn hazard.

SECTION 12: VENTILATION

VENTILATION In a sauna, the air should be changed about 6 times an hour. This can be achieved by making a vent opening (fresh air inlet) in the sauna wall directly below the heater. The air outlet must be lower than the upper benches, as far as possible from the heater and about two feet higher than the fresh air inlet vent, See Diagram 9. It is recommended that ventilation openings meet the requirements of UL Specification 875. The minimum opening should be determined using one of the following formulas:

$$\text{For } R < 31, \quad V \geq 9.3, \quad \text{For } R \geq 31, \quad V \geq 0.3R$$

where R = the floor area of the room in square feet and
 V = the minimum vent size in square inches

SECTION 13: BWT (Bio Water Technique) Technology

The world sauna trend is moving towards higher humidity and lower temperatures. Many find it easier to breathe, the skin feels warm, and the humidity helps induce a sweat. This system will increase the humidity in the room allowing the air temperature to be lower, and still feel hot.

BWT technology provides the ability to increase humidity levels in the sauna room while the heater is warming up and during the sauna session. The continuous soft boil of water during the sauna session increases the humidity in the room to provide a consistent feel. Additional water can be added to the rocks to provide an additional spike of humidity as needed.

How to use BWT: Allow heater to warm up for approximately 20 minutes and add water into the tank through the side of fragrance diffuser with slots. Add approximately 2 cups of fresh water into the tank. Do Not Use Pool or Spa Water.

Fragrance oils can be placed in the side of the fragrance diffuser without the slots. Avoid adding fragrances directly into the water of the BWT. The oils may cause the water to foam and maybe difficult to remove the scent from the tank.

BWT tank and sleeve should always be installed in heater with rocks. Water in the tank is optional and not required if preference is lower humidity.

SECTION 14: MAINTENANCE

The sauna, like a bathroom, should be kept clean and odor free.

Towels or mats should always be used on benches and floor as perspiration otherwise penetrates the soft wood.

Air out the sauna often by keeping the door and vents open when the sauna is not in use. Saunas that are in daily use should be washed down at least once a week to keep them clean and the air fresh. Duckboard should be removed from the sauna, the sauna floor mopped and dried in a conventional manner, and the duckboard thoroughly scrubbed and dried before returning to the sauna room. The sauna heater should be wiped down occasionally with a damp cloth to remove lint and dust. The rocks should be removed once a year for cleaning and small or crumbled rocks replaced.

To clean and remove perspiration stains, use soap or detergent in warm water, best applied with a scrub brush. Badly soiled surfaces may require sanding. Sand paper wrapped around a wooden block works well.

Benches and supporting structure must be inspected annually for potential deterioration due to age, dry rot or abuse. Any boards with signs of deteriorations should be replaced immediately to avoid possible injury.

BWT will accumulate hard-water scale inside the tank as the water is evaporated over time. The water scale will not immediately affect performance. It is recommended to remove the tank from the heater and clean it when you notice a heavy accumulation or when the rocks are changed. Simply tap on the sides of the tank to loosen the scale and then dump into a waste basket. If stubborn scale accumulation remains, you may use any commercially available de-scaling product to remove built-up hard water scale. Follow up with a fresh water rinse before putting BWT back into the heater.

DIAGRAM 12: ROOM TEMPERATURES

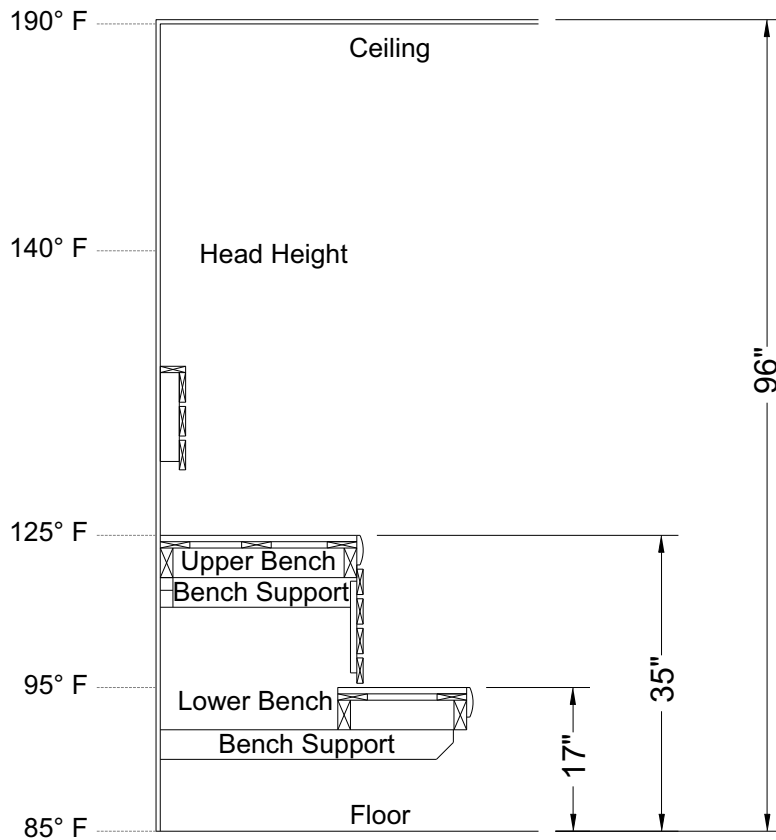

Non-Typical Ceiling Height

Notes:

Temperatures vary in a sauna room by height and distance from heater.

Ventilation will help reduce it but will not eliminate temperature variations.

The hottest part of the room is always at the ceiling directly above the sauna heater and should not exceed 194°F (90°C).

Air temperature will be 15°F to 25°F lower on the opposite side of the room from the heater close to the ceiling.

The temperatures in the elevated view are general numbers. Each sauna room is different due to construction variations and ventilation.

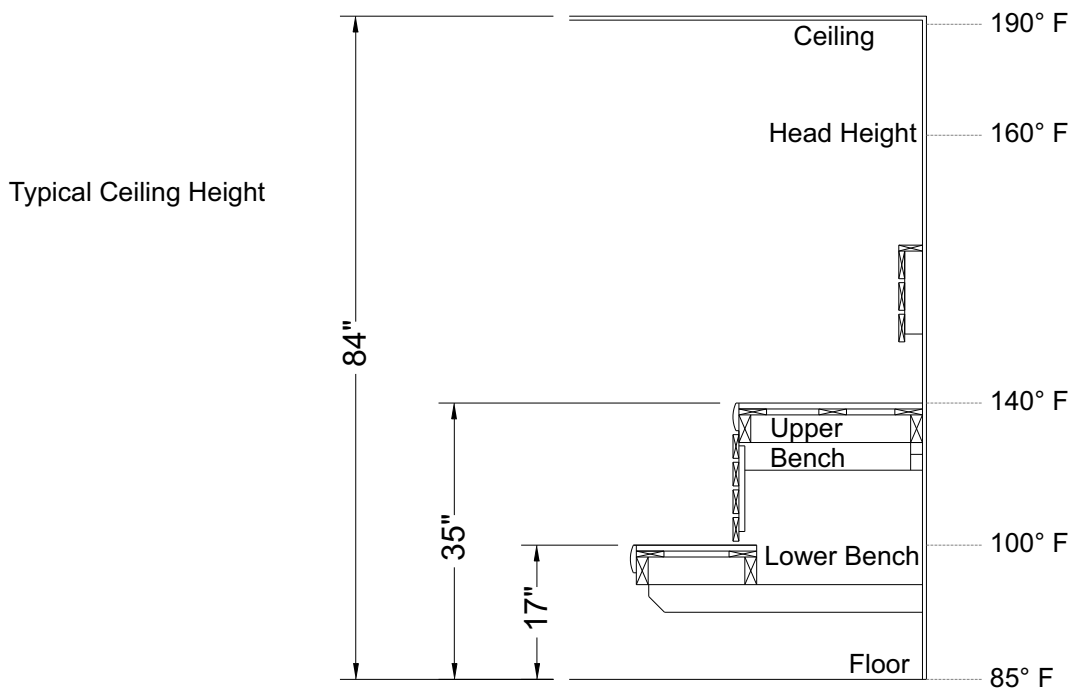

SECTION 15: REPLACEMENT PARTS

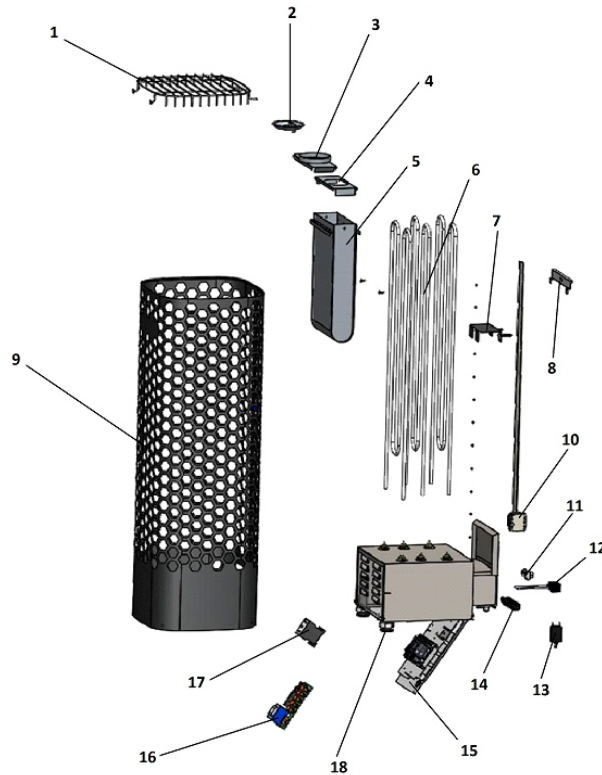

1	8019-517	GUARD,ROCK,HIMALAYA,BLK,SK-ZG	1
2	8221-06	HOLDER,BWT,FRAG CUP,BLACK	1
3	2137-23	COVER,BWT TANK,W/FRAGRANCE HOLDER,HIMALAYA	1
4	N/A	Item 4 is combined with Item 3	N/A
5	8100-483	TANK,WATER,BWT,(MF),HIMALAYA HTRS	1
6	3001-768	ELEMENT,HTR,2267W,208V,SEPC 226-1,HIMALAYA	3
6	3001-769	ELEMENT,HTR,2267W,240V,SEPC 226-1,HIMALAYA	3
6	3001-770	ELEMENT,HTR,3000W,208V,SEPC 238-1,HIMALAYA	3
6	3001-771	ELEMENT,HTR,3000W,240V,SEPC 238-1,HIMALAYA	3
7	8250-086	BRKT,HTR,HIMALAYA,70/90,MOUNTING	1
8	8201-115	BRKT,HOLDER,HIGH LIMIT,HIMALAYA HTR	1
9	8012-527	SHROUD,HTR,HIMALAYA,BLK,OUTER	1
10	3119-510	SWITCH,HIGH LIMIT,55.31529.960	1
11	2100-552	TERMINAL,BLOCK,4-POS,WHT	1
12	5304-019	CABLE,ASSY,FLAT,12",4-COND,RJ10/22 CONNECTORS	1
13	3100-593	FUSE,CIRBRKR,SC,2 AMP,T13-211-2A	1
14	2100-550	TERMINAL,BLOCK,6POS,SPADE,W/3JUMPERS,NLWB,1-1	1
15	8093-001	ENCL,ELECTRICAL CHASSIS,HIMALAYA	1
16	3229-015	PCA,SAUNA,RELAY,HIGH,PAL,SERVICE	1
17	3131-517	CONTACTOR,OKTA 5-1,LC7K09004M7	1
18	8026-020	STAND,ADJ.FEET,HIMALAYA	1
19	8201-039	BRKT,PCA HIGH MNT,SST,VERT,(Himalaya) (Not Shown)	1
20	8012-477	COVER,ELECTRICAL ACCESS,HIMALAYA (Not Shown)	1

SECTION 15: TROUBLESHOOTING

Control will Run but No Heat - Press the (reset) high limit switch on the back right side of heater.

Slow Heat Time or High Limit Tripping - Check rock placement, they will break down over time and reduce the air flow in the heater. Refer to Diagram 10 for proper rock installation. Discard all rock pieces under the size of 2" pieces. Call the number below to order more rocks if needed.

In the event of a fault occurring in the heater system (control panel, temperature sensor, etc.), the LED On/Off indicator will flash red on the control panel.

The fault error code will be displayed with a constant LED light or a flashing LED light under numbers 1-10. See the list below for fault codes.

Constant LED Fault Code (ones marked with "n/a" are not in use):

- 1 Temperature sensor not connected or it is faulty
- 2 n/a
- 3 Heater circuit board overheated
- 4 One or more relay defective
- 5 n/a
- 6 n/a
- 7 Temperature sensor
- 8 n/a
- 9 Clock disconnected
- 10 Power supply to clock disconnected

Flashing LED Fault Code

- 1 n/a
- 2 n/a
- 3 n/a
- 4 Temperature sensor faulty
- 5 Problem with device connection
- 6 n/a
- 7 n/a
- 8 Too many temperature sensors connected
- 9 n/a
- 10 n/a



For troubleshooting or service questions call 1-888-780-4427 and ask to speak with service. Prior to calling, please have the Model and Type number available. You may also email us at

techsupport@tyloheloinc.com

SECTION 16: INSTALLATION PREMIUM CONTROL (1601-33 or 1601-33-1) OPERATION

Page Intentially Left Blank

SECTION 16: INSTALLATION PREMIUM CONTROL (1601-33 or 1601-33-1) OPERATION

Recessed Mounting For the Premium Control

The recessed mounting box allows the control to mount with its surface almost even to the wall surface. Print this page to “Actual” Size on Printer Options. (This will ensure the size of the opening is correct). Cut out the middle of this page on the dotted lines. The hole will be the size of the mounting box. Insert the mounting box in the hole of this page to ensure it is the correct size.

Trace the paper cut out on the wall. Cut a hole in the wall to match the inner dotted line for the mounting box. Run the control cable out of the wall through the hole in the mounting box. Ensure the hole is just big enough to mount the box. Push the mounting box into the hole and turn the mounting screws to pull the tab tight against the inside of the wall. Ensure the box is level and the correct end is UP (there is an arrow on the wall side of the box pointing up).

Connect the Control coupler to the control cable then feed the cables and connector through the hole in the box and into the wall. Test the Control before mounting it into the wall! Once mounted, the Control will be hard to remove! When ready, apply a small amount silicone to the back of the control, carefully push the control into the box, and hold in place.

Note: Do not use the adhesive tape between control and mounting box. It will be too thick and will cause issues with snapping on the Trim Ring.

Press the trim ring on to the front of the box and control. Snap it in, place top and bottom and along both sides.

