

Pro 10.5, 12.0, & 14.4 (Model # 1105-105, 1105-120 & 1105-140)
Laava 10.5, 12.0, & 14.4 (Model # 1105-1052, 1105-1202 & 1105-1402)
Octa 10.5, 12.0, & 14.4 (Model #1106-105, 1106-120, & 1106-140)
 (With separate **Digi Control** panel & contactor box)

Read all instructions carefully before installation. Please leave all instructions and warranty with the owner.

WARNING

Prolonged exposure to elevated temperatures is capable of inducing hyperthermia. Hyperthermia occurs when the internal temperature of the body reaches several degrees above the normal body temperature of 98.6°F. The symptoms of hyperthermia include an increase in the normal temperature of the body, dizziness, lethargy, drowsiness, and fainting. The effects of the hyperthermia include failure to perceive heat, failure to recognize the need to exit the room, unawareness of impending hazard, fetal damage in pregnant women, physical inability to exit the room and unconsciousness.

WARNING

The use of alcohol, drugs, or medication is capable of greatly increasing the risk of fatal hyperthermia.

SECTION 1: GENERAL INFORMATION

These heaters are ETL approved by Intertek for permanent installations. All wiring must be performed in accordance with the NEC and local codes. See **Table 1** for wire and room size requirements.

These heaters are free standing, secured to the floor, with separate controls.

WARNING

Do not take a sauna if using alcohol, drugs or medications.

Pregnant women or persons with poor health should consult their physician before using any sauna.

Caution fire hazard: Do not use the sauna room for drying clothes, bathing suits, etc. Do not hang towels above heater or place any object other than the rocks supplied on the heater. If any darkening of the wall around the heater is noticed discontinue sauna use immediately.

Inspect sauna regularly for required maintenance to heater, control and benches. Replace wood surfaces which show any signs of deterioration.

The heater gets extremely hot during operation and should not be touched or burns may result.

Minors should be adequately supervised whenever near a hot or warming sauna.

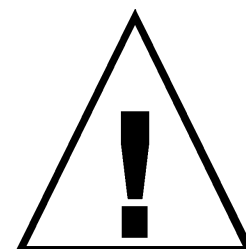

SECTION 2: MOUNTING OF SAUNA HEATER

Carefully locate the heater according to the dimensions shown in Diagram 1 and bolt it to the floor. (Bolts are not supplied with the heater.) Tighten to secure the heater in place.

SECTION 3: PLACING OF ROCKS

The rocks supplied with the heater have been chosen to provide the best heater performance. Use of any other type of rock may void the heaters warranty. Never operate the heater without rocks in place! Rinse the rocks with water before placing in the heater. Place the larger rocks at the bottom and the smallest at the top. Place the rocks loosely so that the air can circulate through the heater. Packing the rocks too tightly may cause the heater high limit switch to trip. The rocks must fully cover the heating elements. Attach the guard with the screws provided.

SECTION 4: ELECTRICAL HOOK-UP

Electrical installation must be made by a licensed electrician in accordance with the National Electrical Code and local regulations.

This heater is intended for use with Digi I, Digi II, or Digi VII controls only. Use of any other control will void the warranty and UL listing. The control must be installed in a dry location outside the sauna room. The location must be selected to allow installation of the thermostat's temperature sensor shown in Diagram 1. (9 foot sensor wire supplied, but may be extended with equivalent 2 conductor wire.)

The model CB 9-3 contactor is required for use with 3 phase heaters, the model CB 9-1 contactor is required for use with single phase heaters. To determine the correct wire size, refer to Table 1. Use copper supply wire only, suitable for minimum 90 degrees C. The heater must be grounded! See the heater diagrams for proper connections.

SECTION 5: TEMPERATURE SENSOR

Route the sensor wire from the contactor box to the sensor location. It may be necessary to drill holes to string the wire through the studs or ceiling joists. Route wires into contactor box and connect to terminals #1 and #2 of J3. **Ensure low voltage wiring and high voltage wiring is separated by a minimum of 4" or an electrical barrier.** With a flat tip screwdriver, unsnap sensor cover from sensor. Mount sensor horizontally to the finished wall directly above heater 2" inches down from ceiling. Refer to Diagrams 1, 2, & 3 for installation information.

SECTION 6: HEATER SCREEN (GUARD RAIL)

Install a wooden heater guard to prevent the sauna bather from accidentally touching the sauna heater. Install the heater guard rail with the height clearances and dimensions shown in Diagram 1.

WARNING

Fire sprinkler systems used inside any sauna room should be properly rated for sauna room temperatures.

Do not pour chlorinated pool or spa water on heater. Excessive water use on heater may cause damage and void warranty.

Do not install a shower in sauna room.

Electric Shock Hazard - High voltage exists within this equipment. There are no user serviceable parts in this equipment. All installation and service to this equipment should be performed by qualified licensed personnel in accordance with local and national codes.

Do not construct sauna room so as to restrict air flow through the bottom of the heater.

Packing the rocks too tightly may cause the heater high limit switch to trip.

DIAGRAM 1

Pro Heater Model # 1105-XXX

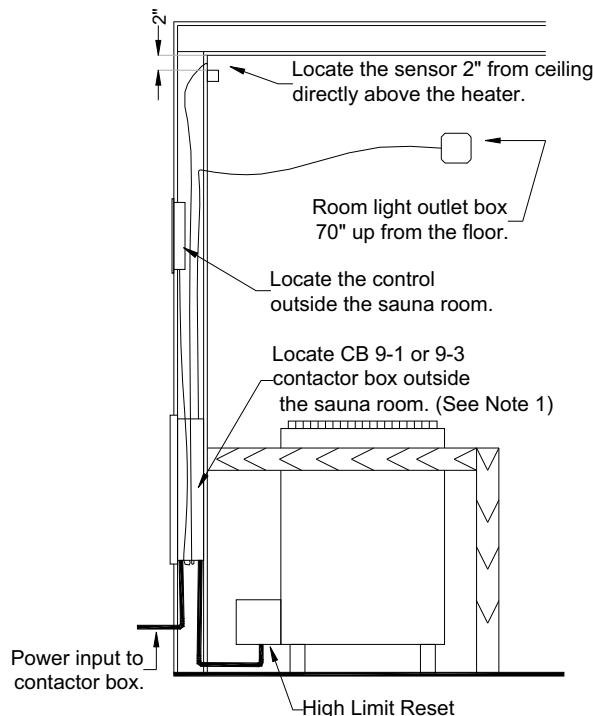
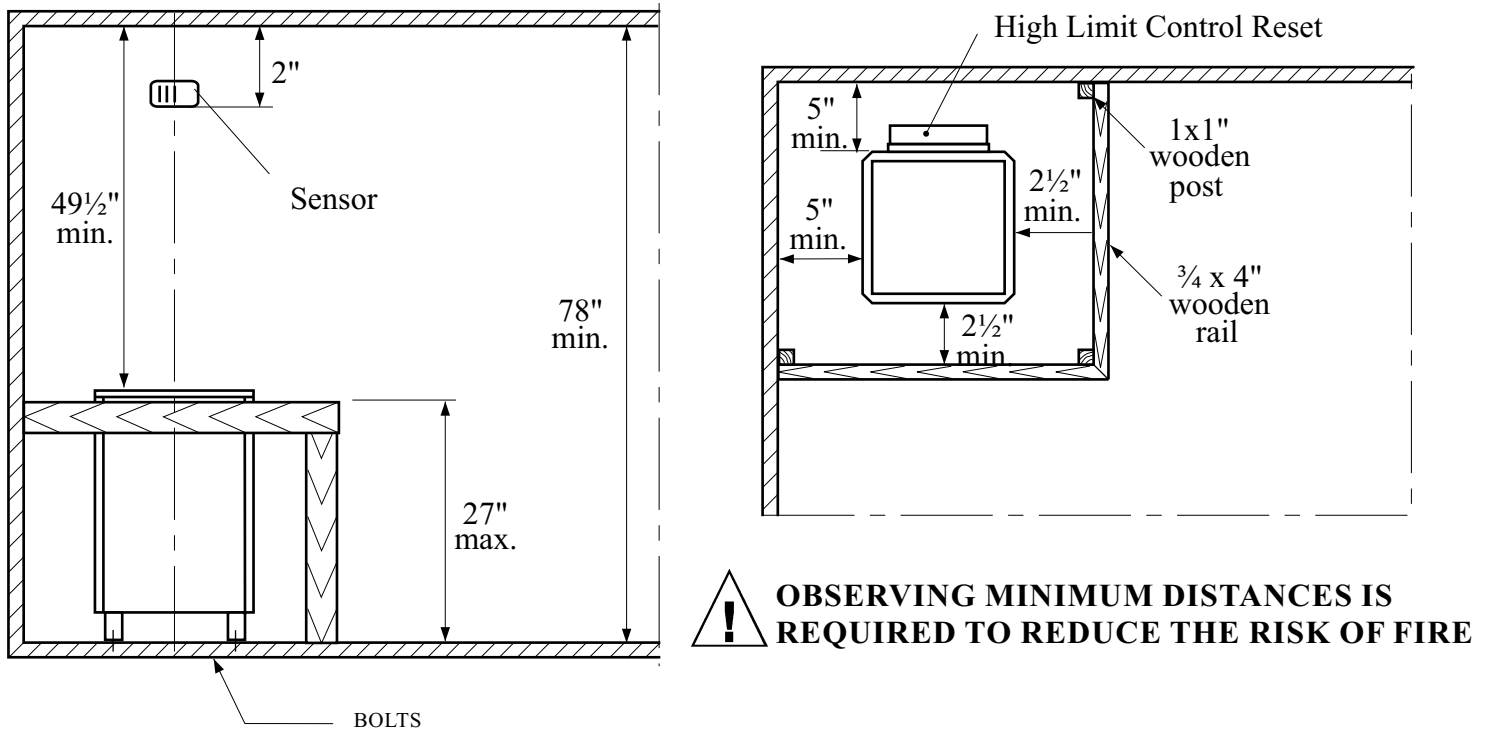

Note 1: The contactor box may be mounted anywhere outside the sauna room. A location should be selected so the front cover is accessible for service and the noise of the contactor pulling in will not be a nuisance.

DIAGRAM 1

Laava Heater 1105-XXX2

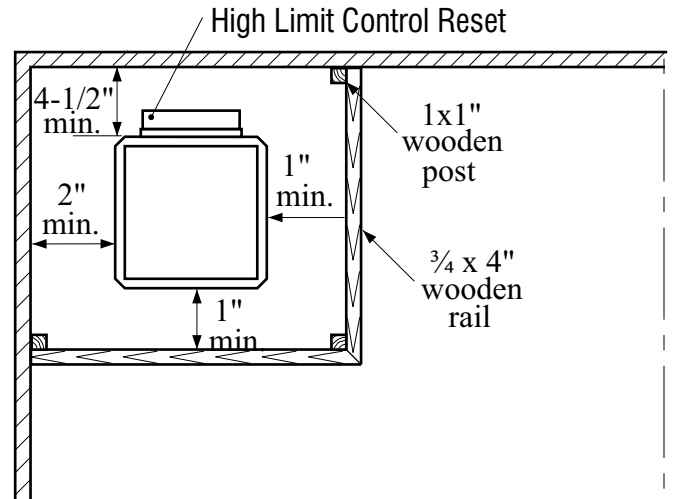
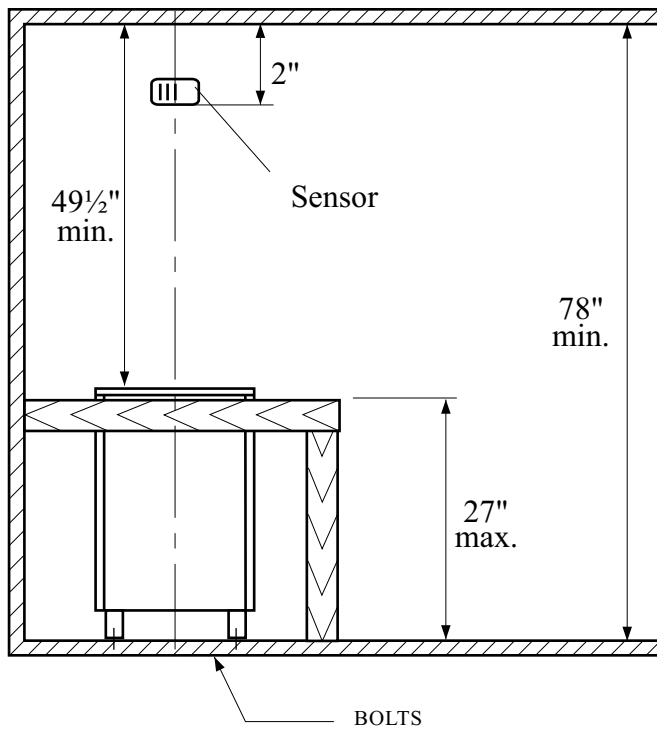

OBSERVING MINIMUM DISTANCES IS REQUIRED TO REDUCE THE RISK OF FIRE

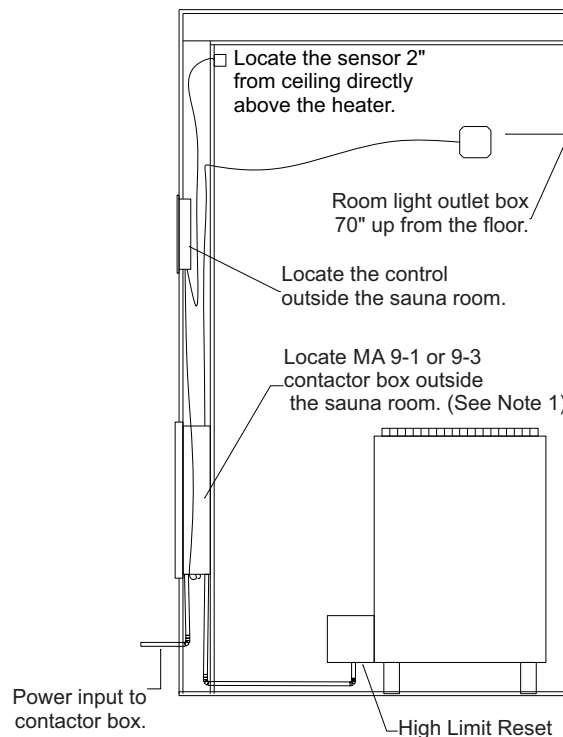

Note 1: The contactor box may be mounted anywhere outside the sauna room. A location should be selected so the front cover is accessible for service and the noise of the contactor pulling in will not be a nuisance.

Provide a service loop into the sauna room to the proposed heater location.

DIAGRAM 1 Continued

Octa Heater Model # 1106-XXX

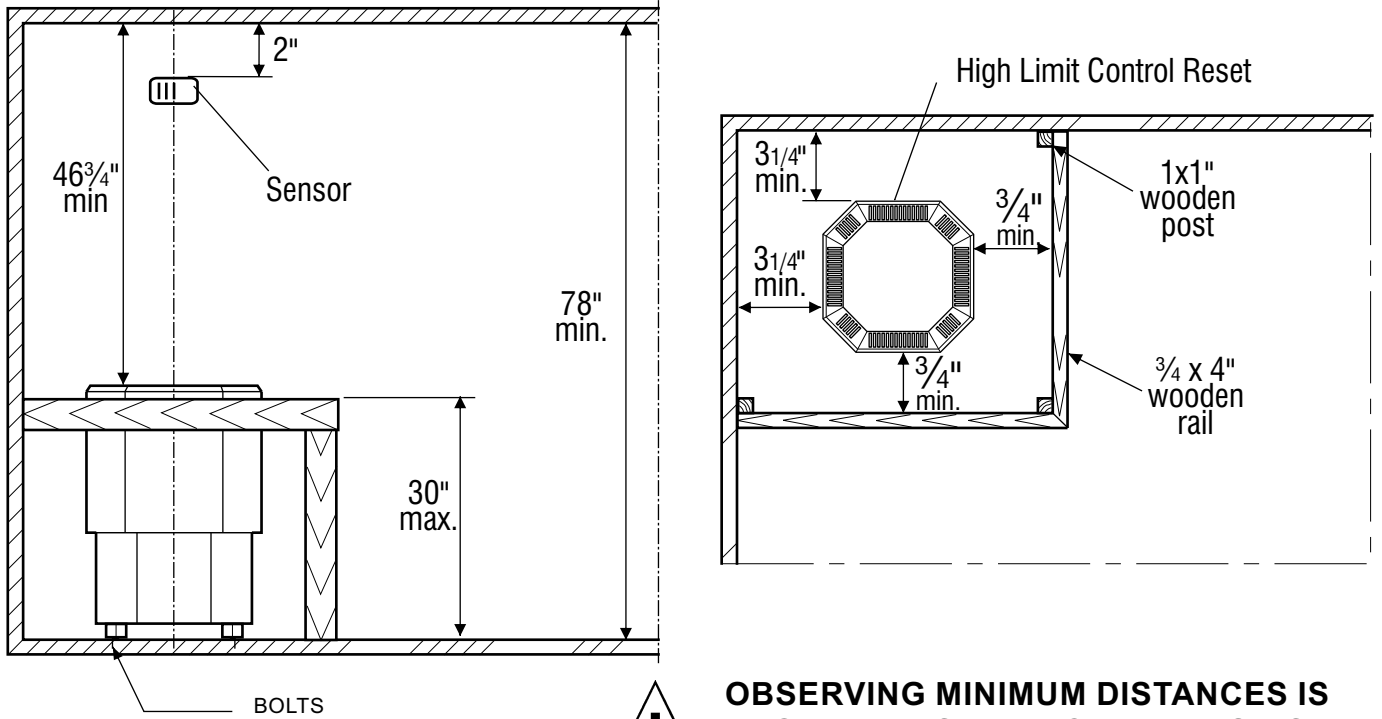

OBSERVING MINIMUM DISTANCES IS REQUIRED TO REDUCE THE RISK OF FIRE

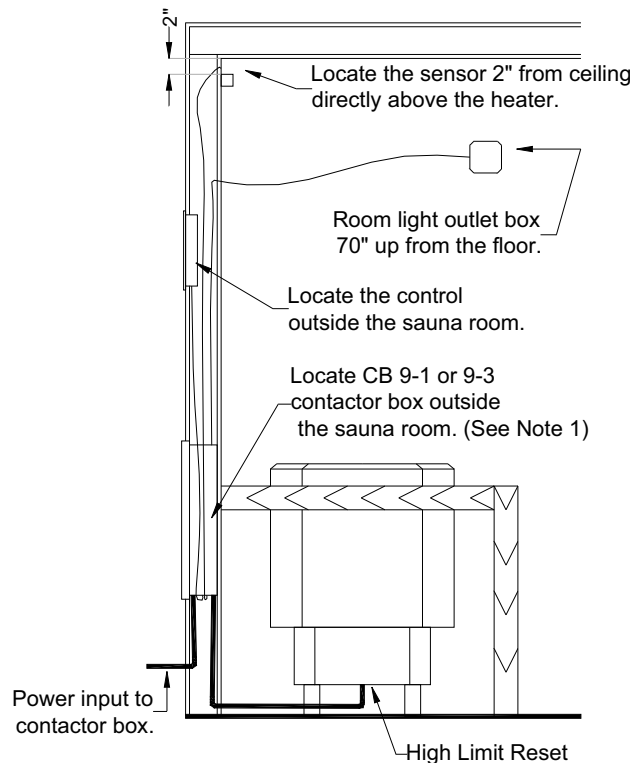

Note 1: The contactor box may be mounted anywhere outside the sauna room. A location should be selected so the front cover is accessible for service and the noise of the contactor pulling in will not be a nuisance.

TABLE 1

Heater Model / Product Number	KW	Minimum Room			Maximum Room		Phase	VAC	* Amps	Contactor Model	Copper Wire Size 90° C					
		Floor Area	Wall Height	Volume Cu.Ft.	Wall Height	Volume Cu.Ft.					** Breaker # and Size	Power Supply to Contactor	Contactor to Heater	Contactor to Heater High Limit	Contactor to Control	Light Circuit or Fan Circuit
Pro 10.5 or Laava 10.5 or Octa 10.5	10.5	48 sq. ft.	78"	390	96"	600	1	208	50.5	CB 9-1 1201-9-1	2 x 40 Amps	4 #8AWG +N+GR	4 #8AWG +GR	2 #14AWG	10 #22 AWG (Supplied)	1 #14AWG +N+GR
							1	240	43.8		2 x 30 Amps	4 #8AWG +N+GR	4 #10AWG +GR	2 #14AWG	10 #22 AWG (Supplied)	1 #14AWG +N+GR
							3	208	29.1	CB 9-3 1201-9-3	1 x 40 Amps	3 #8AWG +N+GR	3 #8AWG +GR	2 #14AWG	10 #22 AWG (Supplied)	1 #14AWG +N+GR
							3	240	25.3		1 x 40 Amps	3 #8AWG +N+GR	3 #8AWG +GR	2 #14AWG	10 #22 AWG (Supplied)	1 #14AWG +N+GR
Pro 12.0 or Laava 12.0 or Octa 12.0	12.0	63 sq. ft.	78"	510	96"	740	1	208	57.7	CB 9-1 1201-9-1	2 x 40 Amps	4 #8AWG +N+GR	4 #8AWG +GR	2 #14AWG	10 #22 AWG (Supplied)	1 #14AWG +N+GR
							1	240	50.0		2 x 30 Amps	4 #10AWG +N+GR	4 #10AWG +GR	2 #14AWG	10 #22 AWG (Supplied)	1 #14AWG +N+GR
							3	208	33.3	CB 9-3 1201-9-3	1 x 40 Amps	3 #8AWG +N+GR	3 #8AWG +GR	2 #14AWG	10 #22 AWG (Supplied)	1 #14AWG +N+GR
							3	240	28.9		1 x 40 Amps	3 #8AWG +N+GR	3 #8AWG +GR	2 #14AWG	10 #22 AWG (Supplied)	1 #14AWG +N+GR
Pro 14.0 or Laava 14.0 or Octa 14.0	14.4	78 sq. ft.	78"	630	96"	950	1	208	69.2	CB 9-1 1201-9-1	2 x 40 Amps	4 #8AWG +N+GR	4 #8AWG +GR	2 #14AWG	10 #22 AWG (Supplied)	1 #14AWG +N+GR
							1	240	60.0		2 x 40 Amps	4 #8AWG +N+GR	4 #8AWG +GR	2 #14AWG	10 #22 AWG (Supplied)	1 #14AWG +N+GR
							3	208	40.0	CB 9-3 1201-9-3	1 x 50 Amps	3 #6AWG +N+GR	3 #6AWG +GR	2 #14AWG	10 #22 AWG (Supplied)	1 #14AWG +N+GR
							3	240	34.6		1 x 50 Amps	3 #6AWG +N+GR	3 #6AWG +GR	2 #14AWG	10 #22 AWG (Supplied)	1 #14AWG +N+GR

* Total amp draw of combined circuits and accessory circuits.

** Single phase heaters are supplied power from two circuits which must be grouped and marked per NEC.

DIAGRAM 2

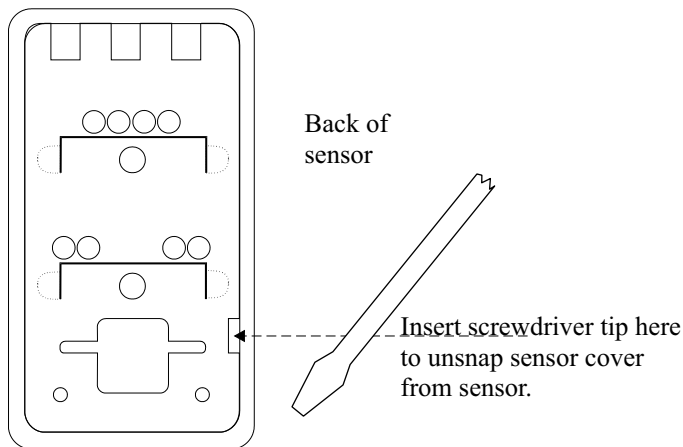

DIAGRAM 3

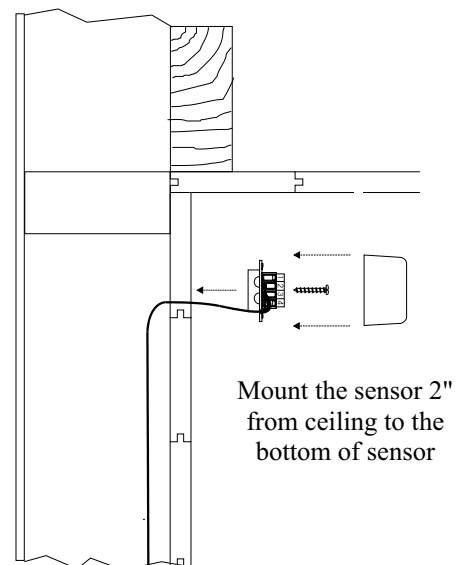

DIAGRAM 4

SINGLE PHASE WIRING DIAGRAM HEATER MODELS:

Pro 10.5, 12.0 & 14.4 Model Number: 1105-105, 1105-120 & 1105-140

Laava 10.5, 12.0 & 14.4 Model Number: 1105-1052, 1105-1202 & 1105-1402

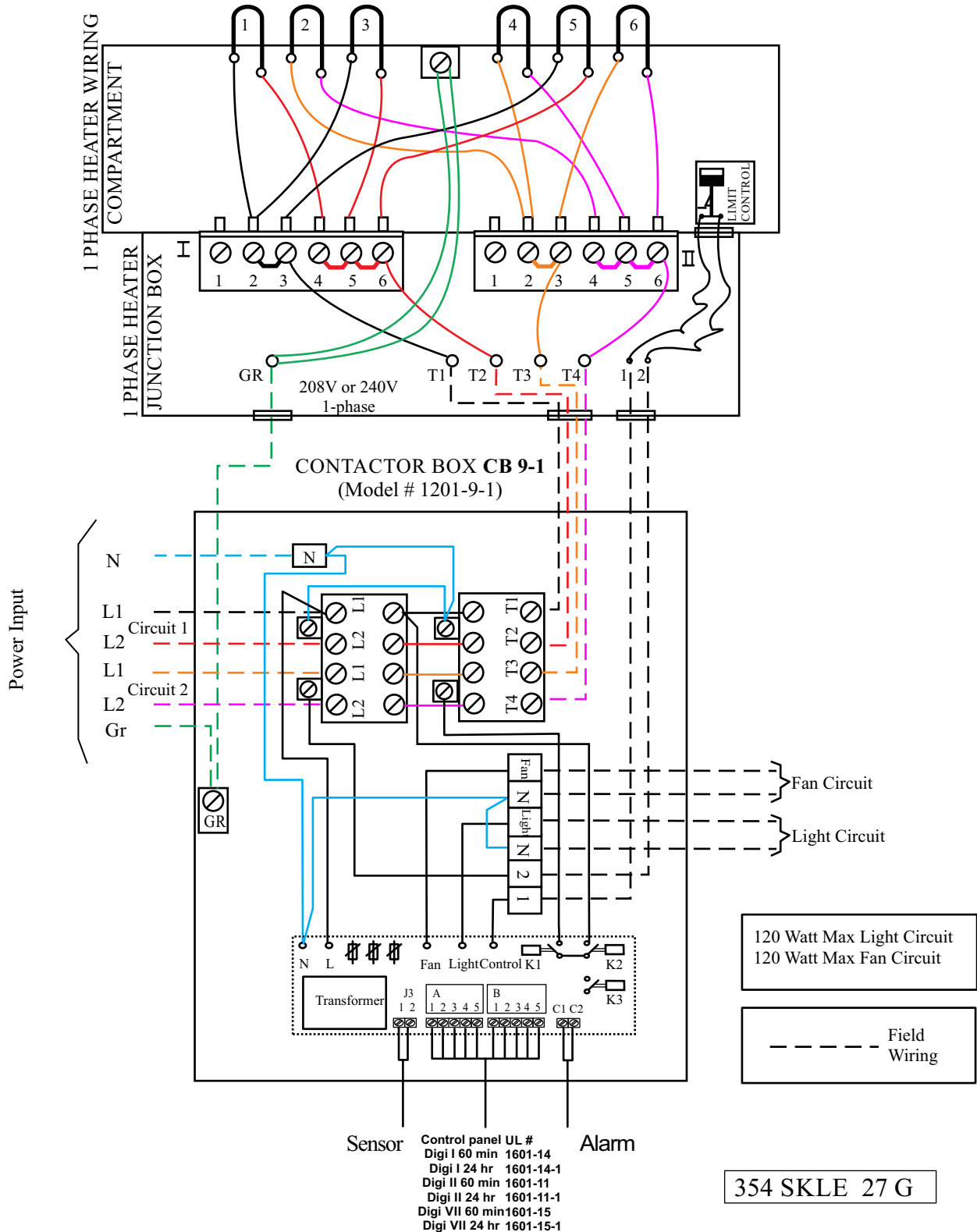
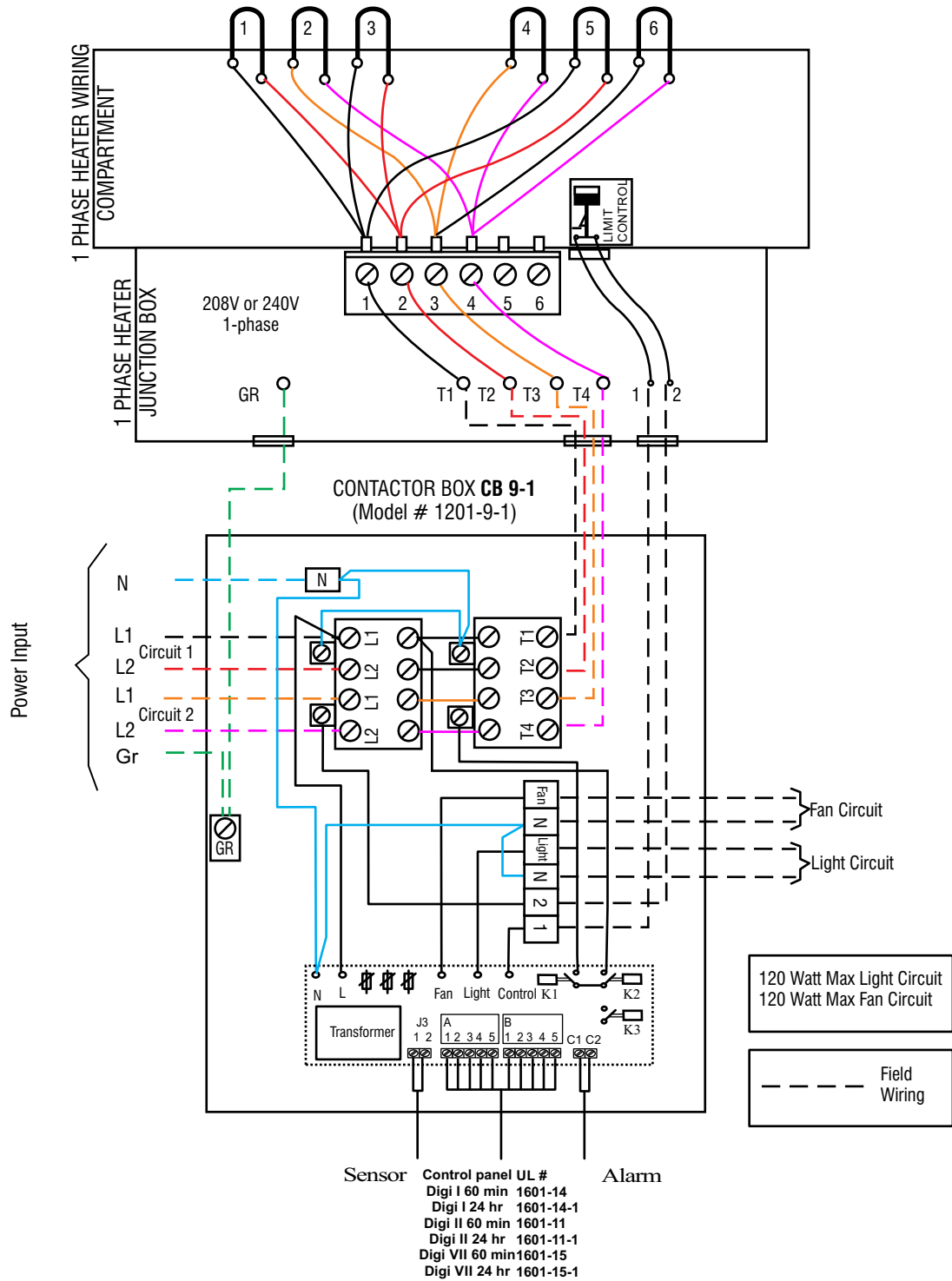

DIAGRAM 4, Continued

**Single Phase Wiring Diagram: Heater Models Octa 10.5, 12.0 & 14.4
Model Number: 1106-105, 1106-120 & 1106-140**



354 SKLF 38 C

DIAGRAM 4, Continued

**Three Phase Wiring Diagram: Heater Models Octa 10.5, 12.0 & 14.4
Model Number: 1106-105, 1106-120 & 1106-140**

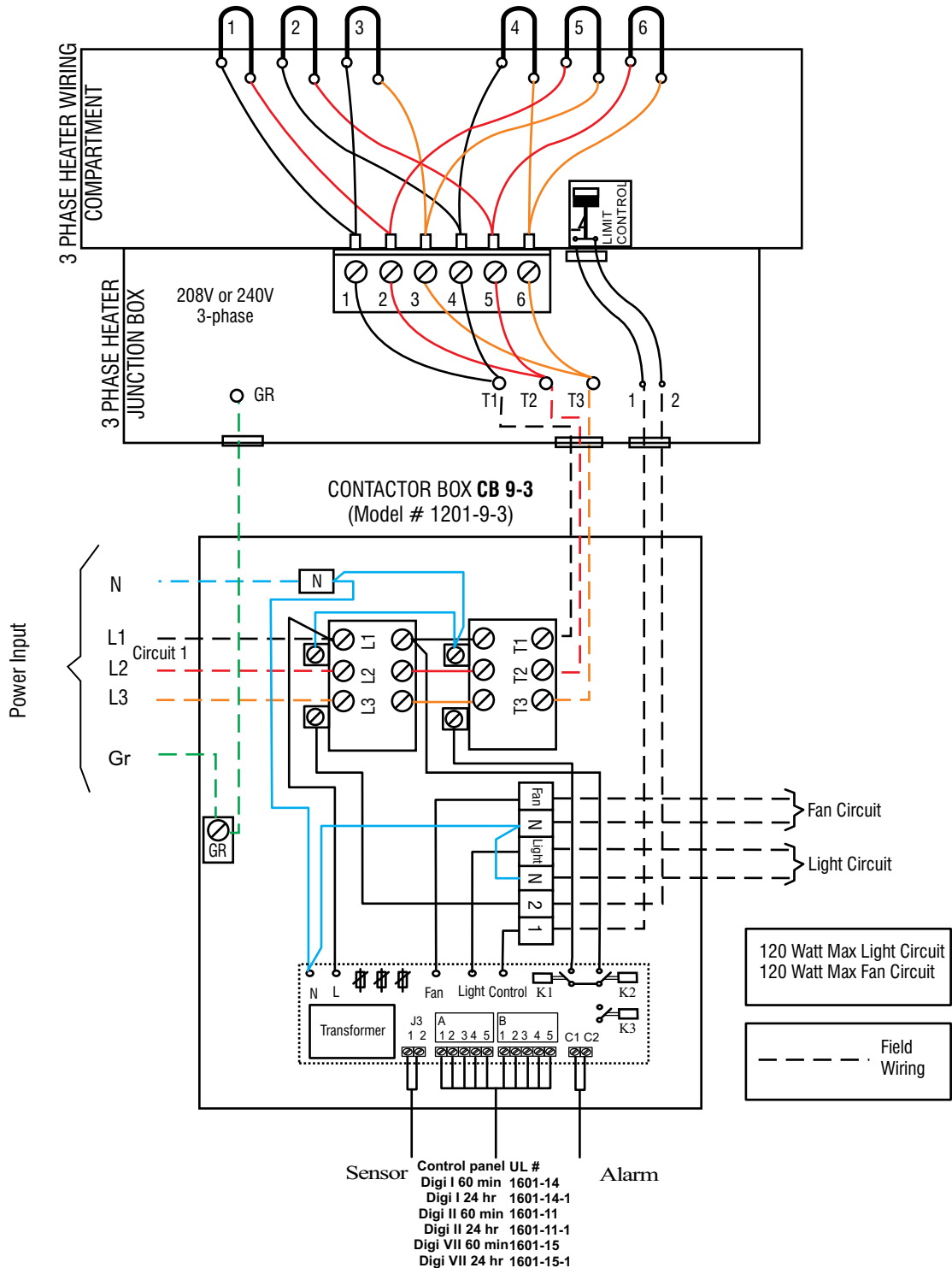

354 SKLF 39 C

SECTION 7: OPERATION

The control for this heater has a thermostat to adjust the sauna temperature and a timer to control when the heater starts and stops. The maximum the timer will allow the heater to operate is 60 minutes. For health and fire safety, never attempt to alter or bypass the timer or thermostat. **The Digi XX 24 hr (Model # 1601-XX-1) control models which can be set to stay on longer than 60 minutes is for commercial use only where an attendant is present.**

The Digi Controls shall be mounted outside the room. The control has 16ft of control wire supplied. The maximum control wire length would be 90ft. Additional wire may be special ordered.

The sensor shall be mounted over the heater 2" from the ceiling; sensor wire is connected to terminals 1 and 2 on the circuit board. Refer to **Diagram 1, 2, & 3.**

Control Overview

Alarms

The Digi II and Digi VII controls are equipped with an alarm that indicates a faulty thermostat sensor and or thermostat wire. The control will display "T1 cable break". During the alarm the control will turn power off to the heater and the control display will remain on. Rectify the fault situation by replacing the sensor or cable and press the On/Off button on control to clear alarm. If problem persists refer to **Section 14.**

Locking Key Pad The Digi II and Digi VII control keypads can be locked. With the control in the Off mode, **press the up arrow key**, then **down arrow key** and then **fan key**. "Locked" will be displayed. This will make all keys inactive until the control is unlocked.

To unlock the control repeat the same sequence.

Digi VII is also equipped with an alarm for high temperature. The alarm setpoint is determined in the Main Menu area of programming. If the control alarms for high temperature, follow the directions on the control to reset the alarm. The sauna should not be used again until the cause of the high temperature alarm has been determined and corrected.

Optional Equipment: There may be an audio and visual alarm connected to the contactor box to attract attention to the situation. The equipment should be mounted outside the sauna but within hearing range.

WARNING

*Do not locate benches over heater. Minimum height of ceiling above heater
Diagram 1.*

*Minimum clearance from heater to wooden surfaces (benches, heater fence etc.
Refer to Diagram 1)*

Use only copper wire of the size and type indicated in the Heater Specification Chart and the temperature rating indicated on the heater junction box.

All heaters and controls must be grounded per NEC to prevent electrical shock in case of unit failure.

Electrical outlets or receptacle must not be installed in a sauna room.

A guardrail or fence is required around the heater to prevent burns from accidental contact.

SECTION 7: OPERATION, DIGI VII

The Digi VII 24 hr (Model # 1601-15-1) control model can be set to stay on longer than 60 minutes. This is for commercial use only where an attendant is present.



Digi VII 60 min (Model # 1601-15) Control Setup:

This setup has **7 different menus**.

To escape from this **Setup Menu**, press the **On/Off** button or the device will **automatically exit** the menu in approx. **4 seconds**.

To enter the Setup Menu press **PROG/OK** button and hold down for approx. **3 seconds** until the following appears in the display:

MENU 1
TIME: 12:00

Setting the Clock: Press the up arrow and hold down: The minutes and hours will begin to change. Set clock to appropriate time. Press **PROG/OK** to save the time in memory.

Next will display:

MENU 2
DAY: MONDAY

Using the arrow keys, select the correct day of the week. Press **PROG/OK**: to save the setting.

Next will display:

MENU 3
LANGUAGE: ENGLISH

Setting Language: Press the up or down arrow key repeatedly until the language you desire appears in the display. Press **PROG/OK** to save the Language in memory.

SECTION 7: OPERATION, DIGI VII CONTINUED

Next will display:

MENU 4

OFFSET: T1 0C

Using the arrow keys, select the calibration value (0 +/-10C).

Example: After reading the temperature on the thermometer in the sauna, you may have noticed that the temperature reading on the sauna thermometer is lower than the display on the control. Set Offset T1 to +4C to get the displayed temperature to match the thermometer. **(This offset does not change the actual temperature, this is just for indication only.)** Press **PROG/OK**: to save the calibration value.

Next will display:

MENU 5

CLOCK: 24 h

Using the arrow keys, select a 12 or 24-hour clock. If a 12-hour clock is selected, AM or PM will appear in the display after the time. Press **PROG/OK**: to save the setting.

Next will display:

MENU 6

TEMPERATURE: C

Using the arrow keys, select the desired temperature scale. (Celsius or Fahrenheit) Press **PROG/OK**: to save the setting.

Next will display:

MENU 7

ALARM: 100

Using the arrow keys, select the desired alarm temperature setpoint. Press **PROG/OK**: to save the setting.

Programming the Daily Programs:

The control is in the Off mode:

Press **ON/OFF** and a greeting appears in the display, the backlight comes on, and the following will appear in the display **MON 5:30 PM** Current day of the week and time.

Press **PROG/OK** button and the display will show View Daily Program.

Next press **PROG/OK** and the following will appear in the display: The first number indicates start time, the length of sauna duration, and the last number is the desired temperature.

5:30 PM MON 5:30 PM is the start time and **MON** is the day

01:00 156F 01:00 is the length of sauna and **156F** is the set temperature. The maximum operational time is 60 minutes or 23 hours depending on the control type.

Changing Start Time

To change the start time press the **Delayed Start Time**  button and the hours and minutes (hh:mm) will appear in the display. **Start Time: 1:00 PM** The start time can now be set using the arrow keys. When the desired time has been selected, press **PROG/OK** to return to previous screen. To bypass the day so no heat cycle is used, press the Delayed Start Time button again and the display will read **Start Time: - :- -**.

SECTION 7: OPERATION, DIGI VII CONTINUED

Changing Sauna Length of Operation

To change the sauna length time press the **Sauna Heat Time**  button and the hours and minutes (hh:mm) will appear in the display. **On Time 1:00** The time can now be set using the arrow keys. When the desired time has been selected, press **PROG/OK** to return to previous screen.

Changing Sauna Temperature

Press the **TEMPERATURE**  button and the temperature value will appear in the display current temperature setting: **156F** The temperature can now be set using the arrow keys. When the desired temperature has been selected, press **PROG/OK** and the display will return to the previous screen. If all the information is correct press **PROG/OK**.

Saving Each Day

The display will read **Copy the data to the next day? No.** If the previous day's data should not be copied to the next day choose No. If the next day should be the same as the previous day, press the arrow keys to display Yes. When the desired answer has been selected, press **PROG/OK** to return to previous screen.

Repeating Program Weekly

Repeat programing each day of the week the same way through Sunday. After Sunday has been approved the display will read **Program Repeat Weekly? No.** If the program should not repeat every week continuously, choose No. If the program should run every week, press the arrow keys to display Yes. When the desired setting has been selected, press **PROG/OK**.

Testing Alarm (optional equipment)

The display will read **Test Alarm?** If the alarm equipment is not connected select No by pressing the arrow keys and press **PROG/OK**. If the equipment is connected and it needs to be tested, select Yes by pressing the arrow keys and press **PROG/OK**. The audio and visual alarm should activate if connected. Press **PROG/OK** to deactivate.

Activating the Program

The control will display **Activate Program?** If the delay program should not be activated, choose No. Press **PROG/OK**, the display will read the current day and time. The control is now waiting to be activated to run by delay program or the user memory buttons.

If the delay program is ready to begin, press the arrow keys to select Yes. When the desired setting have been selected, press **PROG/OK**. The display will read current day and time on the first line and the next programmed day and time will alternately flash on the second line.

Daily Operations of Memory (User buttons):

Press **ON/OFF** and the greeting appears in the display and the backlight comes on.

Press the appropriate button to start operation of the **Light** and **Fan** ; press again to shut off. The corresponding symbols will appear in the display.

Press **Memory Button 1 - 4**: The system will turn on and operate according to the button's preset time and temperature until program has expired. The control will then turn off.

SECTION 7: OPERATION, DIGI II

The Digi II 24 hr (Model # 1601-11-1) control model can be set to stay on longer than 60 minutes. This is for commercial use only where an attendant is present.

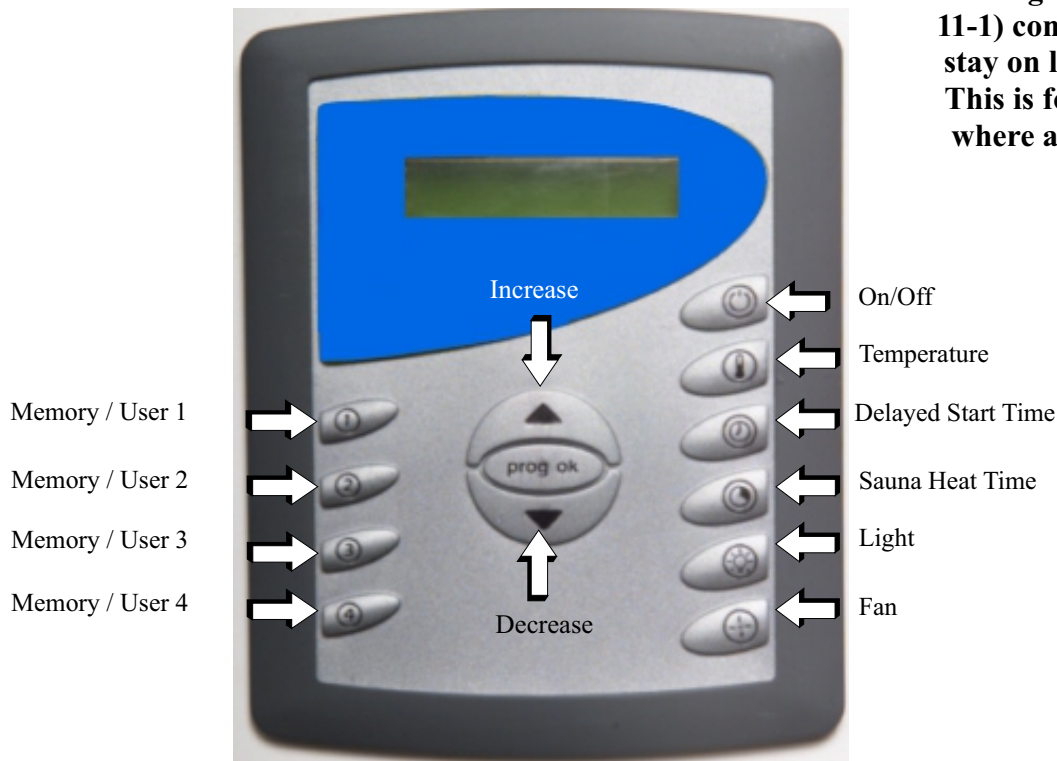

Control Setup for Control Model Digi II 60 min (Model # 1601-11):

This setup has **6 different menus**.

To escape from this **Setup Menu**, press the **On/Off** button or the device will **automatically exit** the menu in approx. **4 seconds**.

To enter the Setup Menu press **PROG/OK** button and hold down for approx. **3 seconds** until the following appears in the display:

MENU 1
TIME: 12:00

Setting the Clock: Press the up arrow and hold down: The minutes and hours will begin to change. When the hour reads the correct time, release the up arrow key and enter minutes by repeatedly pressing the arrow key for each minute. Press **PROG/OK** to save the time in memory.

Next will display:

MENU 2
LANGUAGE: ENGLISH

Setting Language: Press the up or down arrow key repeatedly until the language you desire appears in the display. Press **PROG/OK** to save the Language in memory.

SECTION 7: OPERATION, DIGI II CONTINUED

Programming Memory (User buttons) continued...

Press the **TEMPERATURE**  button and the temperature value will appear in the display current temperature setting: **156F** The temperature can now be set using the arrow keys. When the desired temperature has been selected, press **PROG/OK** and the display will return to the previous screen.

To save the values to memory, press the memory buttons 1. The display will now read:

PROGRAM1
01:00 156F

Press **PROG/OK** once again to return the display to **5:30 PM 01:00**
156F

To program another memory button go back to the beginning of Programming Memory (user buttons). Press **ON/OFF** to exit the programming mode.

Review When the device is in Off mode, you can review your programmed values by pressing the memory buttons.

Setting Time Delay without SaunaSmart:

The control is in the Off mode:

Press **ON/OFF** and A greeting appears in the display and the backlight comes on.

Press **PROG/OK** and the following will appear in the display start time, sauna length, and temperature.

5:30 PM 01:00 The maximum operational time is 60 minutes for the heater.
156F

Press Time Delay  button and the hours and minutes (hh:mm) will appear in the display.

START:
12:00 PM

The start time can now be set using the arrow buttons. When the desired time has been selected, press **PROG/OK** and the display will return to the previous screen.

Press the **Sauna Heat Time**  button and the hours and minutes (hh:mm) will appear in the display. Sauna Length: **01:00** The duration can now be set using the arrow keys. When the desired time has been selected, press **PROG/OK** to return to previous screen.

Press the **TEMPERATURE**  button and the temperature value will appear in the display current temperature setting: **156F** The temperature can now be set using the arrow keys. When the desired temperature has been selected, press **PROG/OK** and the display will return to the previous screen.

Press **PROG/OK** and hold down for about 3 seconds until the following appears in the display:

3:00 PM
5:30 PM SAUNA

3:00 PM is the current time and **5:30 PM** is the start time, when the sauna is automatically turned on.

SECTION 7: OPERATION, DIGI II CONTINUED

Setting Time Delay with Saunasmart:

Saunasmart means choosing the time to enter the hot room, not the time to turn the heater on. The system will calculate when to turn on in relation to entry time. The control will be able to determine how long the system needs to run to reach set temperature. This function usually takes 3 heat cycles to get time versus temperatures memorized.

The entire programming process is the same as "Setting Time Delay without Saunasmart" except for the final step of programming display.

3:00 PM

3:00 PM is the current time

5:30 PM SMART

5:30 PM is the time the room is ready to enter.

Setting Program for a Repeat Sauna Everyday:

Taking a sauna every day at the same time automatically without reprogramming, do the following: Press **PROG/OK**. The following will appear in the display start time, duration and temperature.

5:30 PM 01:00 156F The maximum allowable operation time for the heater to operate is 60 minutes.

Press **PROG/OK** and hold down for about 3 seconds until the following appears in the display:

3:00 PM

5:30 PM SMART (or **Sauna** depending on what delay mode is selected)

3:00 PM is the current time and **5:30 PM is the time the room is ready to enter.**

Daily Operations of Memory (User buttons):

Press **ON/OFF** and the greeting appears in the display and the backlight comes on.

Press the appropriate button to start operation of the **Light** and **Fan** ; press again to shut off. The corresponding symbols will appear in the display.

Press **Memory Button 1 - 4**: The system will turn on and operate according to the button's preset time and temperature until program has expired. The control will then turn off.

Daily Operations Using Time Delay Functions:

Press **ON/OFF** and the greeting appears in the display and the backlight comes on.

Next press **PROG/OK** and the following will appear in the display start time, duration and temperature.

5:30 PM 01:00 156F The maximum operational time is 60 minutes for the heater.

If all information is correct: Press **PROG/OK** and hold down for about 3 seconds until the following appears in the display: Leave the control on and return when system is ready.

3:00 PM

5:30 PM SMART (or **Sauna** depending on what delay mode is selected)

If the control settings are not correct, go to the "**Setting Time Delay**" portion of the manual to program control and then return to portion when completed.

SECTION 7: OPERATION, DIGI I

Control Model Digi I 60 min (Model # 1601-14):

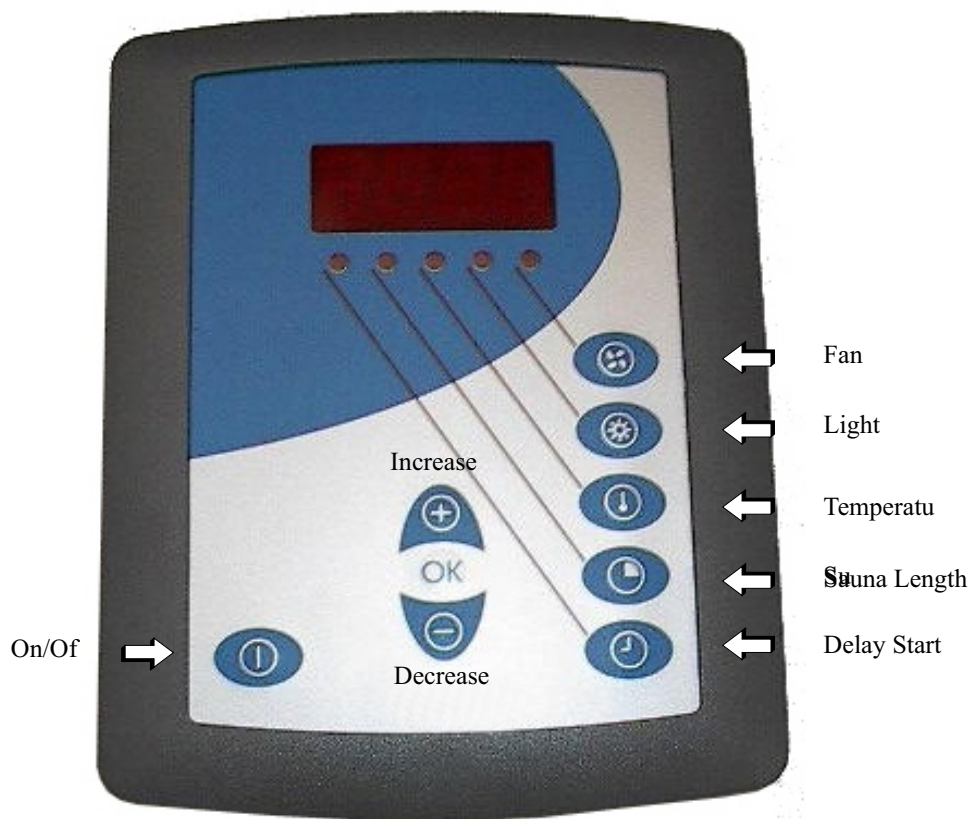

The 1601-14-1 control model can be set to stay on longer than 60 minutes. This is for commercial use only where an attendant is present.

SECTION 7: OPERATION, DIGI I CONTINUED

Control Setup for Digi I 60 min Control (Model # 1601-14):

Setting Temperature Scale:

The control in the Off mode:

Press **ON/OFF**  FAHR will appear. Press the Up button to toggle between Fahrenheit and Celsius. Press **OK** when the appropriate scale is displayed.

Setting Time Delay:

Press Time Delay  button and the indicator light will flash when making changes. Press the up or down arrow to get the appropriate setting. When the desired time has been selected, press **OK**.

Press the **Sauna Heat Time**  button and the indicator light will flash when making changes. Press the up or down arrow to get the appropriate setting (60 minutes maximum). When the desired time has been selected, press **OK**.

Press the **TEMPERATURE**  button and the indicator light will flash when making changes. Press the up or down arrow to get the appropriate setting. When the desired temperature has been selected, press **OK**.

Press **OK** and hold down for **approximately 3 seconds** until time comes on and the “:” in the time starts to flash. The control is programmed to the above settings.

Starting Sauna Immediately:

The control is in the Off mode:

Press **ON/OFF**  **00:00** will appear. (Number indicates minutes)

Press the **SAUNA HEAT TIME**  button and the indicator light will flash when making changes. Press the up or down arrow to get the appropriate setting (60 minutes maximum). When the desired time has been selected, press **OK**.

Press the **TEMPERATURE**  button and the indicator light will flash when making changes. Press the up or down arrow to get the appropriate setting. When the desired temperature has been selected, press **OK**.

Press **OK** and hold down for **approximately 3 seconds** until time comes on and the “:” in the time starts to flash. The control is programmed to the above settings.

Note: Control holds the previous sauna length and temperature setting.

Control Setup for Digi I 24 hr Control (Model # 1601-14-1):

Control type 1601-14-1 is for commercial applications with attendance on duty. This control allows the sauna to heat for a maximum of 23 hours. Refer to 1601-14 control operation for programming. Clock will mean hours and minutes.

SECTION 8: LIMIT CONTROL (RESET BUTTON)

The sauna heater has a built-in High Limit control, which automatically turns off the heater if the temperature inside in the sauna room rises to an abnormally high level.

To restart the heater, let the heater cool and the timer run down to zero (off), then push the reset button on the bottom of the heater, See Diagram 1. If the High Limit continually shuts off the heater, refer to Section 14 for Troubleshooting.

SECTION 9: HOW TO TAKE A SAUNA

- When taking a sauna, allow time to relax completely.
- Remove clothing and jewelry...if required, wear a towel loosely.
- After 10 minutes or when perspiration begins, leave sauna and relax in dressing area...follow with a cool shower.
- Cooling time should equal time spent in sauna. Enter sauna room again and stay 5 or 10 minutes.
- Repeat the cycle 2 or 3 times; end with a brisk shower...rinse in cool water.
- Dress when completely dry and perspiration has stopped.
- Some sauna bathers enjoy the soothing effect of steam by splashing water on the heated sauna rocks. Use only one dipper full (approx. ½ cup) at a time and take care to keep clear of the steam as it rises off the rocks.
- Do not smoke, exercise or drink alcoholic beverages in the sauna room.
- Do not pour chlorinated pool or spa water on the heater or corrosion damage may result.

SECTION 10: WARNING PLACARDS

Two metal placards are included in the Installation Instruction Envelope packaged with every Sauna Heater. The CAUTION placard must be attached to the interior wall of the sauna room directly above the heater where it is visible to the bather. The WARNING placard must be attached to the door of the sauna room.



Shower



Sauna (10 - 15 min.)



Shower or swim



Rest (10 - 15 min.)



Relax with juice or water

You liked it?
Do it once again and
you will feel great.

SECTION 11: ROOM CONSTRUCTION

For safety and reliability, the following rules must be addressed.

- No permanent locking or latch system is to be used on the sauna door.
- Acceptable door fittings are: magnetic catches, friction catches, spring or gravity loaded closures. The door must always open outwards.
- No shower may be installed in a sauna room.
- No electrical receptacle shall be installed inside the sauna room.
- The enclosed **WARNING: Reduce the risk of overheating** ... warning plate must be mounted on or alongside the door outside the sauna room at about eye level.
- The enclosed **CAUTION: Reduce the risk of fire** ... caution plate must be mounted on the interior wall above the heater.
- The heater should not be operated without its container properly filled with rocks and the rock guard in place.
- If an intercom speaker is installed, it should be away from the heater and as close to the floor as possible.
- If a room light is installed, it should be a surface mounted bracket type. Wall mounted lights should be about 70" above the floor. Ceiling mounted lights should be of an approved type with a junction box that is remote to the fixture itself. Use only a fixture that uses A.F. or fixture type internal wiring. A 60 watt bulb should provide sufficient lighting.
- Fire sprinkler systems installed inside any sauna room should be properly rated for sauna room temperatures.
- Always mount the heater according to these installation instructions.

DIAGRAM 5

TYPICAL PRE-CUT WALL CONSTRUCTION

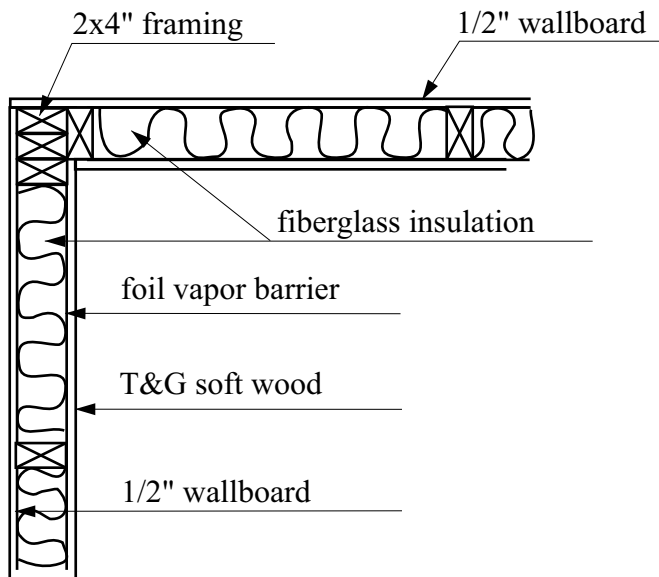

The "CAUTION" and "WARNING" placards must be mounted in accordance with Section 10.

⚠ WARNING

REDUCE THE RISK OF OVERHEATING

- * Exit immediately if uncomfortable, dizzy, or sleepy. Staying too long in a sauna is capable of causing overheating.
- * Supervise children at all times.
- * Check with a doctor before use if pregnant, in poor health, or under medical care.
- * Breathing heated air in conjunction with consumption of alcohol, drugs, or medication is capable of causing unconsciousness.

⚠ CAUTION

REDUCE THE RISK OF FIRE

Do Not Place Combustible Material On The Heater At Any Time.

For safety purpose sauna door must open out and not lock.

Never use a wood stain, seal or preservative on the inside of your sauna room.

Light fixtures get very hot during operation. Locate light fixture where it will not be a burn hazard.

DIAGRAM 6: ROOM TEMPERATURES

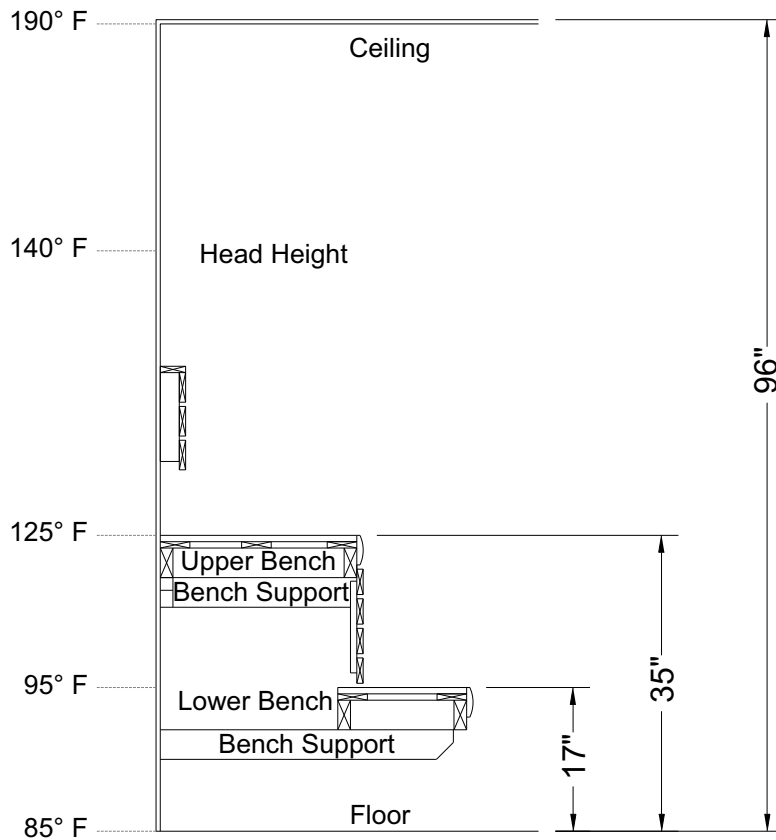

Non-Typical Ceiling Height

Notes:

Temperatures vary in a sauna room by height and distance from heater.

Ventilation will help reduce it but will not eliminate temperature variations.

The hottest part of the room is always at the ceiling directly above the sauna heater and should not exceed 194°F (90°C).

Air temperature will be 15°F to 25°F lower on the opposite side of the room from the heater close to the ceiling.

The temperatures in the elevated view are general numbers. Each sauna room is different due to construction variations and ventilation.

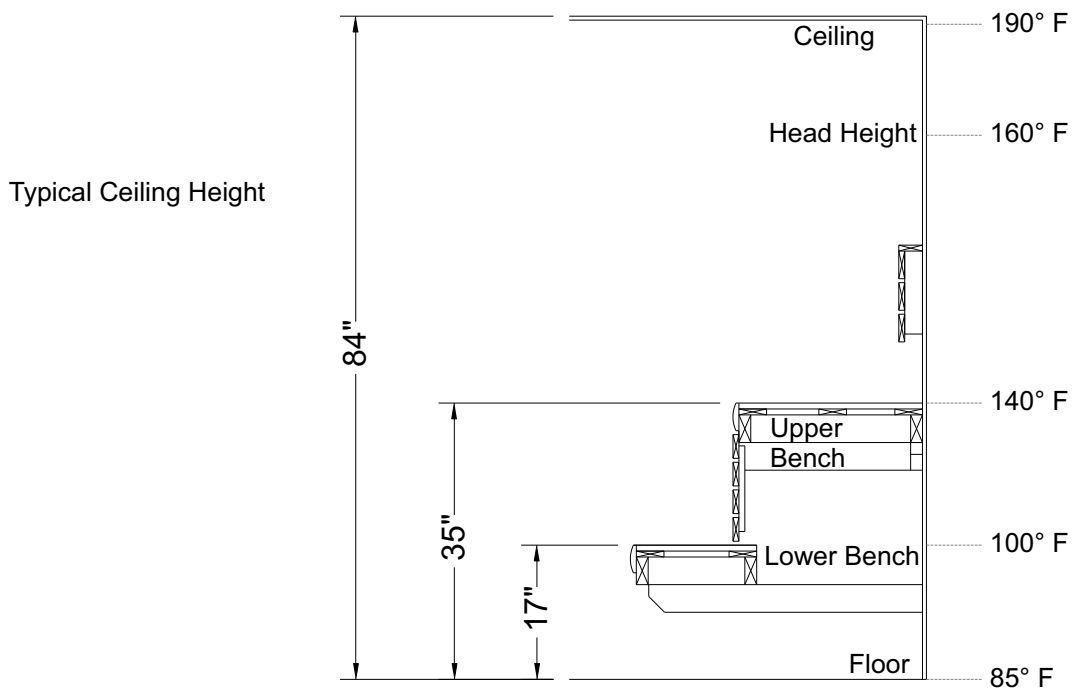

Typical Ceiling Height

SECTION 12: VENTILATION

VENTILATION Ventilation shall be provided in a sauna, the air should be changed about 6 times an hour. This can be achieved by making a vent opening (fresh air inlet) in the sauna wall directly below the heater. The air outlet must be lower than the upper benches, as far as possible from the heater and about two feet higher than the fresh air inlet vent, See Diagram 7.

The minimum opening should be determined using one of the following formulas:

$$\begin{aligned} \text{For } R < 31, \quad V &\geq 9.4 \\ \text{For } R \geq 31, \quad V &\geq 0.3R \end{aligned}$$

R = the floor area of the room in square feet

V = the minimum vent size in square inches

DIAGRAM 7

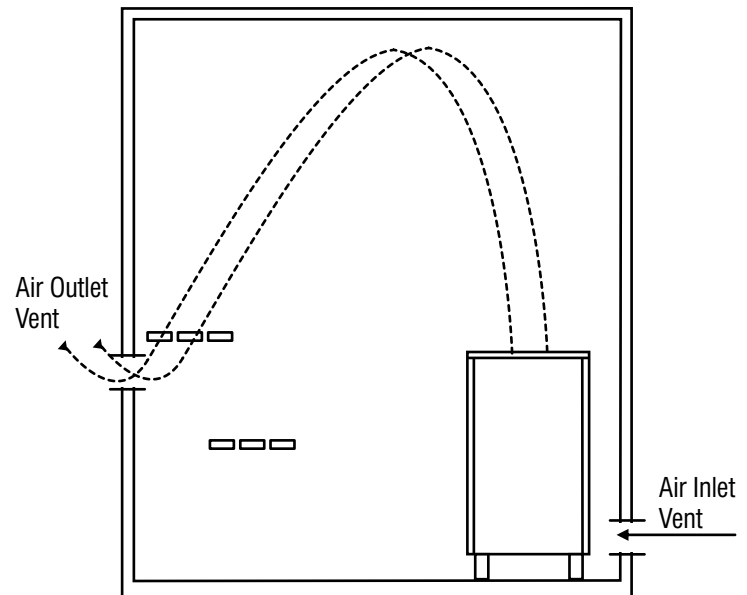

SECTION 13: MAINTENANCE

The sauna, like a bathroom, should be kept clean and odor free.

Towels or mats should always be used on benches and floor as perspiration otherwise penetrates the soft wood.

Air out the sauna often by keeping the door and vents open when the sauna is not in use. Saunas that are in daily use should be washed down at least once a week to keep them clean and the air fresh. Duckboard should be removed from the sauna, the sauna floor mopped and dried in a conventional manner, and the duckboard thoroughly scrubbed and dried before returning to the sauna room. The sauna heater should be wiped down occasionally with a damp cloth to remove lint and dust. The rocks should be removed once a year for cleaning and small or crumbled rocks replaced.

To clean and remove perspiration stains, use soap or detergent in warm water, best applied with a scrub brush. Badly soiled surfaces may require sanding. Sand paper wrapped around a wooden block works well.

Benches and supporting structure must be inspected annually for potential deterioration due to age, dry rot or abuse. Any boards with signs of deterioration should be replaced immediately to avoid possible injury.

SECTION 14: TROUBLESHOOTING

Control will Operate but No Heat - Press (reset) the high limit switch on the bottom of heater.

Slow Heat Time or High Limit Tripping - Check rock placement, they will break down over time and reduce the air flow in the heater. Refer to Section 3 for proper rock installation. Discard all rocks under the size of 3" peices. Call the number below to order more rocks if needed.

For troubleshooting or service questions call 1-888-780-4427 and ask to speak with service. Prior to calling, please have the Model and Type number available. You may also email us at

techsupport@tyloheloinc.com